

*Si necesita ayuda para comprender esta información, por favor llame  
503-588-6173*

## DECISION OF THE PLANNING ADMINISTRATOR

**CLASS 3 SITE PLAN REVIEW / CLASS 2 ADJUSTMENT / TREE REGULATION  
VARIANCE CASE NO.: SPR-ADJ-TRV22-36**

**APPLICATION NO.: 22-110042-RP / 22-110045-ZO / 22-113625-PLN**

**NOTICE OF DECISION DATE:** August 2, 2022

**SUMMARY:** Proposed development of a Vietnam War Memorial.

**REQUEST:** A Class 3 Site Plan Review for site improvements including walkways, memorial statues and viewing areas, and a Tree Variance to conduct ground distributing construction within 30-percent of the critical root zone of three significant trees. The applicant proposes to preserve all three trees and conduct all construction activities in accordance with an arborist report and Oregon Parks and Recreation Department. The proposal includes one Class 2 Adjustment to eliminate the opacity requirement for a proposed wall (part of memorial).

For development site approximately eleven acres in size, zoned PM (Capital Mall) and PA (Public Amusement) and located at 900 Court Street NE 97301 (Marion County Assessors Map and Tax Lot number: 073W27AA / 200 & 300 and 073W26BB / 4900).

**APPLICANT:** Chris Havel, Oregon Parks and Recreation Department

**LOCATION:** 900 Court St NE, Salem OR 97301

**CRITERIA:** Salem Revised Code (SRC) Chapters 220.005(f)(3) – Class 3 Site Plan Review; 250.005(d)(2) – Class 2 Adjustments; 808.045(d) – Tree Variances

**FINDINGS:** The findings are in the attached Decision dated August 2, 2022.

**DECISION:** The **Planning Administrator APPROVED** Class 3 Site Plan Review, Class 2 Adjustment, and Tree Regulation Variance Case No. SPR-ADJ-TRV22-36 subject to the following conditions of approval:

- Condition 1:** The applicant shall plant six trees, at least 1.5-inch caliper in size, within the 20-foot setback. Two trees shall be abutting State Street and Four abutting Cottage Street NE.
- Condition 2:** The impacted 31-inch Wester Red Cedar, 45-inch Blue Atlas Cedar and 40-inch Douglas Fir tree shall be preserved and are not authorized for removal.
- Condition 3:** The applicant shall follow all Arborist recommendation and construction methods within the Critical Root Zone of each identified tree, as described in Attachment C.

# NOTICE OF DECISION

PLANNING DIVISION  
555 LIBERTY ST. SE, RM 305  
SALEM, OREGON 97301  
PHONE: 503-588-6173  
FAX: 503-588-6005



The rights granted by the attached decision must be exercised, or an extension granted, by August 18, 2026, or this approval shall be null and void.

Application Deemed Complete: July 15, 2022  
Notice of Decision Mailing Date: August 2, 2022  
Decision Effective Date: August 18, 2022  
State Mandate Date: November 12, 2022

Case Manager: Olivia Dias, Current Planning Manager, [odias@cityofsalem.net](mailto:odias@cityofsalem.net), 503-540-2343

This decision is final unless written appeal and associated fee (if applicable) from an aggrieved party is filed with the City of Salem Planning Division, Room 320, 555 Liberty Street SE, Salem OR 97301, or by email at [planning@cityofsalem.net](mailto:planning@cityofsalem.net), no later than 5:00 p.m., Wednesday, August 17, 2022. The notice of appeal must contain the information required by SRC 300.1020 and must state where the decision failed to conform to the provisions of the applicable code section, SRC Chapter(s) 220, 250, and 808. The appeal fee must be paid at the time of filing. If the appeal is untimely and/or lacks the proper fee, the appeal will be rejected. The Hearings Officer will review the appeal at a public hearing. After the hearing, the Hearings Officer may amend, rescind, or affirm the action, or refer the matter to staff for additional information.

The complete case file, including findings, conclusions and conditions of approval, if any, is available for review by contacting the case manager, or at the Planning Desk in the Permit Application Center, Room 305, City Hall, 555 Liberty Street SE, during regular business hours.

<http://www.cityofsalem.net/planning>

**BEFORE THE PLANNING ADMINISTRATOR OF THE CITY OF SALEM**

**DECISION**

**IN THE MATTER OF APPROVAL OF ) FINDINGS & ORDER**  
**CLASS 3 SITE PLAN REVIEW, )**  
**CLASS 2 ADJUSTMENT, )**  
**AND TREE VARIANCE )**  
**CASE NO. SPR-ADJ-TRV22-36 )**  
**900 COURT STREET NE - 97301 ) AUGUST 2, 2022**

In the matter of the application for Class 3 Site Plan Review, Class 2 Adjustment, and Tree Variance applications submitted by the Oregon Parks and Recreation Department represented by Abbate Designs LLC, the Planning Administrator, having received and reviewed evidence and the application materials, makes the following findings and adopts the following order as set forth herein.

**REQUEST**

Summary: Proposed development of a Vietnam War Memorial.

Request: A Class 3 Site Plan Review for site improvements including walkways, memorial statues and viewing areas, and a Tree Variance to conduct ground distributing construction within 30-percent of the critical root zone of three significant trees. The applicant proposes to preserve all three trees and conduct all construction activities in accordance with an arborist report and Oregon Parks and Recreation Department. The proposal includes one Class 2 Adjustment to eliminate the opacity requirement for a proposed wall (part of memorial).

For development site approximately eleven acres in size, zoned PM (Capital Mall) and PA (Public Amusement) and located at 900 Court Street NE – 97301 (Marion County Assessors Map and Tax Lot number: 073W27AA / 200 & 300 and 073W26BB / 4900).

A vicinity map illustrating the location of the property is attached hereto and made a part of this staff report (**Attachment A**).

**PROCEDURAL FINDINGS**

**1. Proposal**

Site plan review is intended to provide a unified, consistent, and efficient means to review proposed development that requires a building permit, other than single-family, duplex residential, and installation of signs, to ensure that such development meets all applicable requirements imposed by the Salem Revised Code (SRC). SRC 220.005(b)(3) requires Class 3 Site Plan Review for any development that requires a building permit, and that involves a land use decision or limited land use decision, as those terms are defined in ORS 197.015.

Class 3 Site Plan Review is required for this application pursuant to SRC 220.005(b)(3)(C) because a Class 2 Adjustment has been requested, and a Class 2

Driveway Approach Permit is required for the proposed driveway approach onto Truax Drive SE.

## 2. Background

On May 16, 2022, a consolidated application for Class 3 Site Plan Review, and Class 2 Adjustment was filed for the proposed development. After additional information was provided, including submission of a Tree Variance, the applications were deemed complete for processing on July 15, 2022. The 120-day state mandated decision deadline for this consolidated application is November 12, 2022.

The applicant's proposed site plan is included as **Attachment B** and the applicant's written statement addressing the approval criteria is included as **Attachment C**.

## SUBSTANTIVE FINDINGS

### 3. Summary of Record

The following items are submitted to the record and are available: 1) all materials and testimony submitted by the applicant, including any applicable professional studies such as traffic impact analysis, geologic assessments, stormwater reports, and; 2) materials, testimony, and comments from public agencies, City Departments, neighborhood associations, and the public. All application materials are available on the City's online Permit Application Center at <https://permits.cityofsalem.net>. You may use the search function without registering and enter the permit number listed here: 22 110042.

### 4. Neighborhood Association and Public Comments

The subject property is located within the boundaries of the Central Area Neighborhood Development Organization (CANDO).

Applicant Neighborhood Association Contact. SRC 300.310 requires an applicant to contact the neighborhood association(s) whose boundaries include, and are adjacent to, property subject to specific land use application requests. Pursuant to SRC 300.310(b)(1), land use applications included in this proposed consolidated land use application request require neighborhood association contact. On July 15, 2022, the applicant contacted CANDO informing them of the proposed project.

Neighborhood Association Comment: Notice of the application was provided to CANDO pursuant to SRC 300.520(b)(1)(B)(v), which requires notice to be sent to any City-recognized neighborhood association whose boundaries include, or are adjacent to, the subject property. As of the date of completion of this staff report, no comments have been received from the neighborhood association.

#### Homeowners Association

The subject property is not located within a Homeowners Association.

## Public Comment

Notice was also provided, pursuant to SRC 300.520(b)(1)(B)(iii), (vi), & (vii), to all property owners and tenants within 250 feet of the subject property. No public comment was received during the comment period.

## **5. City Department Comments**

Public Works Department - Reviewed the proposal and provided a memo which is included as **Attachment D**.

Building and Safety Division - Reviewed the proposal and indicated no site concerns.

Fire Department - Reviewed the proposal and indicated no site concerns.

## **6. Public Agency Comments**

No Public Agency comments were received during the comment period.

## **DECISION CRITERIA FINDINGS**

### **7. Analysis of Class 3 Site Plan Review Approval Criteria**

Salem Revised Code (SRC) 220.005(f)(3) provides that an application for a Class 3 Site Plan Review shall be granted if the following criteria are met. The following subsections are organized with approval criteria, followed by findings of fact upon which the decision is based. Lack of compliance with the following criteria is grounds for denial or for the issuance of conditions of approval to satisfy the criteria.

***SRC 220.005(f)(3)(A): The application meets all applicable standards of the UDC.***

**Finding:** The proposal includes construction of a Vietnam Memorial. One adjustment is requested to the opacity standard for a wall and a tree removal variance to conduct ground disturbing activities within 30-percent of the critical root zone three Significant trees.

### **Use and Development Standards – PM (Capitol Mall) Zone:**

*SRC 545.005(a) – Uses:*

**Finding:** The proposal includes development of a Vietnam War Memorial associated with the State Capitol Building. Governmental Services uses are permitted in the PM zone per Table 545-1.

*SRC 545.010(a) – Lot Standards:*

The minimum lot area for uses other than single family and two-four family is 10,000 square feet in size with a 50-foot minimum width, 80-foot minimum depth and 16-feet of street frontage.

**Finding:** The subject property is currently 11.18 acres in size and has more than 1,000 feet of frontage on Court Street NE and State Street NE. In addition, the property has more than 300 feet of frontage along Cottage Street NE and Waverly Street NE. The subject property is in compliance with the minimum lot standards of the PM zone.

*SRC 545.010(b) – Density Standards:*

There is no minimum density in the PM zone and a maximum density for two-four family uses of 28 dwelling units per acre.

**Finding:** The proposal does not include any dwelling unit; therefore, the standard is not applicable.

*SRC 545.010(c) – Setbacks:*

**North:** Adjacent to the north is right-of-way for Court Street NE. Buildings and accessory structures abutting a street require a setback of 20 feet. Vehicle use areas require a minimum 6-10 foot setback per Chapter 806 adjacent to a street. Fences and walls within ten feet of a property line abutting a street shall not exceed eight feet in height and any portion of a wall above 30 inches in height shall be less than 25 percent opaque.

**South:** Adjacent to the south is right-of-way for State Street NE. Buildings and accessory structures abutting a street require a setback of 20 feet. Vehicle use areas require a minimum 6-10 foot setback per Chapter 806 adjacent to a street. Fences and walls within ten feet of a property line abutting a street shall not exceed eight feet in height and any portion of a wall above 30 inches in height shall be less than 25 percent opaque.

**East:** Adjacent to the east is right-of-way for Waverly Street NE. Buildings and accessory structures abutting a street require a setback of 20 feet. Vehicle use areas require a minimum 6-10 foot setback per Chapter 806 adjacent to a street. Fences and walls within ten feet of a property line abutting a street shall not exceed eight feet in height and any portion of a wall above 30 inches in height shall be less than 25 percent opaque.

**West:** Adjacent to the west is right-of-way for Cottage Street NE. Buildings and accessory structures abutting a street require a setback of 20 feet. Vehicle use areas require a minimum 6-10 foot setback per Chapter 806 adjacent to a street. Fences and walls within ten feet of a property line abutting a street shall not exceed eight feet in height and any portion of a wall above 30 inches in height shall be less than 25 percent opaque.

**Finding:** The proposal does not include a building or vehicle use area. Setbacks are not applicable. The proposal includes a wall within a ten-foot setback of the abutting street, which is addressed below.

*SRC 545.010(d) – Lot Coverage, Height:*

There is a 60-percent maximum lot coverage requirement and a maximum height of 70-feet for uses other than single family and two – four family uses.

**Finding:** The proposal is less than 60-percent lot coverage and does not include a building. The wall height is addressed below.

*SRC 545.010(e) - Landscaping:*

- (A) Setbacks. Required setbacks shall be landscaped. Landscaping shall conform to the standards set forth in SRC Chapter 807.
- (B) Vehicle Use Areas. Vehicle use areas shall be landscaped as provided under SRC Chapter 806 and SRC Chapter 807.

**Finding:** Landscape and irrigation plans will be reviewed for conformance with the requirements of SRC Chapter 807 at the time of building permit application review.

*SRC 545.010(f) – Outdoor Storage:*

*Outdoor storage shall be screened from streets and adjacent properties.*

**Finding:** The proposal does not include any outdoor storage; therefore the standard does not apply.

## **General Development Standards SRC 800**

*SRC 800.050(a) – Fences, Walls, Hedges, Gates and Retaining Walls.*

*Fences in nonresidential zones shall not exceed a maximum height of twelve feet, however abutting a street, fences and walls shall not exceed a maximum height of eight feet when located within 10 feet of the abutting street. Any portion of the fence or wall above 30 inches in height shall be less than 25 percent opaque when viewed at any angle at a point 25 feet away from the fence or wall.*

**Finding:** The proposed wall (Vietnam Memorial) is less than eight feet in height, but is solid in nature. The applicant has requested a Class 2 Adjustment to eliminate the standard that the wall is 25 percent opaque. The Class 2 Adjustment is addressed below.

*SRC 800.055(a) – Solid Waste Service Areas Applicability.*

Solid waste service area design standards shall apply to all new solid waste, recycling, and compostable services areas, where use of a solid waste, recycling, and compostable receptacle of 1 cubic yard or larger is proposed.

**Finding:** The proposal does not include an exterior solid waste service area enclosure; all trash and recycling activities occur within a designated room of the building. Receptacles will be maneuvered manually outdoors into position for servicing and afterwards will be brought back indoors. Therefore, the standards of SRC 800.055 are not applicable to this proposal.

*SRC 800.065 – Pedestrian Access.*

Except where pedestrian access standards are provided elsewhere under the UDC, all developments, other than single family, two family, three family, four family, and multiple family developments, shall include an on-site pedestrian circulation system developed in conformance with the standards in this section.

**Finding:** The pedestrian access standards of SRC Chapter 800 apply to the proposed development.

*SRC 800.065(a)(1) – Pedestrian Connection Between Entrances and Streets.*

(A) A pedestrian connection shall be provided between the primary entrance of each building on the development site and each adjacent street. Where a building has more than one primary building entrance, a single pedestrian connection from one of the building's primary entrances to each adjacent street is allowed; provided each of the building's primary entrances are connected, via a pedestrian connection, to the required connection to the street.

**Finding:** Direct pedestrian access is provided from the primary entrances of each building to all abutting streets.

(B) Where an adjacent street is a transit route and there is an existing or planned transit stop along street frontage of the development site, at least one of the required pedestrian connections shall connect to the street within 20 feet of the transit stop.

**Finding:** The exiting bus stops are located on the opposite side of the streets and not abutting the subject property.

*SRC 800.065(a)(2) – Pedestrian Connection Between Buildings on the same Development Site.*

Where there is more than one building on a development site, a pedestrian connection(s), shall be provided to connect the primary building entrances of all the buildings.

**Finding:** There is one building on the site, therefore this standard is not applicable.

*SRC 800.065(a)(3) – Pedestrian Connection Through Off-Street Parking Areas.*

(A) Surface parking areas. Except as provided under subsection (a)(3)(A)(iii) of this section, off-street surface parking areas greater than 25,000 square feet in size or including four or more consecutive parallel drive aisles shall include pedestrian connections through the parking area to the primary building entrance as provided in this subsection.

**Finding:** The proposal does not include any off-street parking area and there isn't one on site.

(B) Parking structures and parking garages. Where an individual floor of a parking structure or parking garage exceeds 25,000 square feet in size, a pedestrian connection shall be provided through the parking area on that floor to an entrance/exit.

**Finding:** The development site does not include any existing or proposed parking structures or garages; therefore, this standard is not applicable.



***SRC 800.065(a)(4) – Pedestrian Connection to Existing or Planned Paths and Trails.***

Where an existing or planned path or trail identified in the Salem Transportation System Plan (TSP) or the Salem Comprehensive Parks System Master Plan passes through a development site, the path or trail shall:

- (A) Be constructed, and a public access easement or dedication provided; or
- (B) When no abutting section of the trail or path has been constructed on adjacent property, a public access easement or dedication shall be provided for future construction of the path or trail.

**Finding:** There is not a planned pedestrian path or trail in the proximity of the subject property.

***SRC 800.065(a)(5) – Pedestrian Connection to Abutting Properties.***

Whenever a vehicular connection is provided from a development site to an abutting property, a pedestrian connection shall also be provided.

**Finding:** The development site does not share a connection with adjoining properties, consistent with the requirements of this section.

***SRC 800.065(b)(1) – Design and Materials.***

Required pedestrian connections shall be in the form of a walkway, or may be in the form of a plaza. Walkways shall conform to the following:

- (A) Materials and width. Walkways shall be paved with a hard-surface material meeting the Public Works Design Standards, and a minimum of five feet in width.
- (B) Where a walkway crosses driveways, parking areas, parking lot drive aisles, and loading areas, the walkway shall be visually differentiated from such areas through the use of elevation changes, a physical separation, speed bumps, a different paving material, or other similar method. Striping does not meet this requirement, except when used in a parking structure or parking garage.
- (C) Where a walkway is located adjacent to an auto travel lane, the walkway shall be raised above the auto travel lane or separated from it by a raised curb, bollards, landscaping or other physical separation. If the walkway is raised above the auto travel lane it must be raised a minimum of four inches in height and the ends of the raised portions must be equipped with curb ramps. If the walkway is separated from the auto travel lane with bollards, bollard spacing must be no further than five feet on center.

***SRC 800.065(b)(2) – Design and Materials.***

Wheel stops or extended curbs shall be provided along required pedestrian connections to prevent the encroachment of vehicles onto pedestrian connections.

**Finding:** Proposed pedestrian connections are five feet in width and a hard surface, meeting the standard.

***SRC 800.065(c) – Lighting.***

The on-site pedestrian circulation system shall be lighted to a level where the system can be used at night by employees, customers, and residents.

**Finding:** Exterior light fixtures are proposed along the building frontage that will illuminate the pedestrian walkways in compliance with this section.

### **Off-Street Parking, Loading, and Driveways SRC 806**

*SRC 806.005(a) - Off-Street Parking; When Required.*

Off-street parking shall be provided and maintained as required under SRC Chapter 806 for each proposed new use or activity.

**Finding:** The proposal does not include development of a new off-street parking area or building; therefore, these standards are not applicable.

### **Landscaping**

All required setbacks shall be landscaped with a minimum of 1 plant unit per 20 square feet of landscaped area. A minimum of 40 percent of the required number of plant units shall be a combination of mature trees, shade trees, evergreen/conifer trees, or ornamental trees. Plant materials and minimum plant unit values are defined in SRC Chapter 807, Table 807-2.

All building permit applications for development subject to landscaping requirements shall include landscape and irrigation plans meeting the requirements of SRC Chapter 807.

**Finding:** Landscape and irrigation plans will be reviewed for conformance with the requirements of SRC 807 at the time of building permit application review. The applicant is removing three, non-significant, trees from the setback. The applicant has proposed to replace the trees pursuant to SRC 807 at a two to one ratio. The following conditions applies:

**Condition 1:** The applicant shall plant six trees, at least 1.5-inch caliper in size, within the 20-foot setback. Two trees shall be abutting State Street and Four abutting Cottage Street NE.

### **Natural Resources**

*SRC 601 – Floodplain:* Development in the floodplain shall be regulated to preserve and maintain the capability to the floodplain to convey the flood water discharges and to minimize danger to life and property.

**Finding:** Public Works staff has reviewed the Flood Insurance Study and Flood Insurance Rate Maps and has determined that no floodplain or floodway areas exist on the subject property.

*SRC 808 - Preservation of Trees and Vegetation:* The City's tree preservation ordinance, under SRC Chapter 808, provides that no person shall remove a significant tree (Oregon White Oak greater than 20 inches in diameter at breast height or any other tree greater than 30 inches in diameter at breast height) (SRC 808.015) or a tree or native vegetation in a riparian corridor (SRC 808.020), unless the removal is excepted

under SRC 808.030(a)(2), undertaken pursuant to a permit issued under SRC 808.030(d), undertaken pursuant to a tree conservation plan approved under SRC 808.035, or permitted by a variance granted under SRC 808.045.

**Finding:** There are several protected trees identified on the subject property. The applicant has requested a Tree Variance to locate sections of the memorial within 30% of the critical root zone of three significant trees. The findings addressing the location to the memorial are addressed below.

*SRC 809 - Wetlands:* Grading and construction activities within wetlands are regulated by the Oregon Department of State Lands (DSL) and US Army Corps of Engineers. State and Federal wetland laws are also administered by the DSL and Army Corps, and potential impacts to jurisdictional wetlands are addressed through application and enforcement of appropriate mitigation measures.

**Finding:** According to the Salem-Keizer Local Wetland Inventory (LWI) the subject property does not contain any wetland areas or hydric soils.

*SRC 810 - Landslide Hazards:* A geological assessment or report is required when regulated activity is proposed in a mapped landslide hazard area.

**Finding:** According to the City's adopted landslide hazard susceptibility maps and SRC Chapter 810 (Landslide Hazards), there are no mapped landslide hazard areas on the subject property.

***SRC 220.005(f)(3)(B): The transportation system provides for the safe, orderly, and efficient circulation of traffic into and out of the proposed development, and negative impacts to the transportation system are mitigated adequately.***

**Finding:** Cottage Street NE meets the right-of-way width and improvement standards for their street classification per the Salem TSP; therefore, no right-of-way dedication is required as a condition of the proposed development.

Court Street NE and State Street NE do not meet current standards for their classification per the Salem TSP. The proposal includes the installation of a Vietnam Memorial, which is not a building addition subject to 803.040(a); therefore, no right-of-way dedication or street improvements are required.

***SRC 220.005(f)(3)(C): Parking areas and driveways are designed to facilitate safe and efficient movement of vehicles, bicycles, and pedestrians.***

**Finding:** The proposal requires no new driveways; this criterion is met.

***SRC 220.005(f)(3)(D): The proposed development will be adequately served with City water, sewer, stormwater facilities, and other utilities appropriate to the nature of the development.***

**Finding:** The Public Works Department has reviewed the applicant's preliminary plan for this site. The water, sewer, and storm infrastructure are available within surrounding streets/areas and are adequate to serve the proposed development.

## **8. Analysis of Class 2 Adjustment Approval Criteria**

Salem Revised Code (SRC) 250.005(d)(2) provides that an application for a Class 2 Adjustment shall be granted if the following criteria are met. The following subsections are organized with approval criteria, followed by findings of fact upon which the decision is based. Lack of compliance with the following criteria is grounds for denial or for the issuance of conditions of approval to satisfy the criteria.

***SRC 250.005(d)(2)(A): The purpose underlying the specific development standard proposed for adjustment is:***

- (i) Clearly inapplicable to the proposed development; or***
- (ii) Equally or better met by the proposed development.***

**Finding:** The applicant is requesting one Class 2 Adjustment to:

*Eliminate the opacity requirement for a proposed wall (part of memorial)*

The applicant indicates that the majority of the memorial is set back from the property line and those small sections needing the adjustment are 30-inches in height. This provides for adequate vision clearance and a pleasant pedestrian environment. The intent of the standard is to ensure an adequate pedestrian experience and vehicle safety and to not have solid walls along sidewalks or property lines. The purpose of the memorial is to engage pedestrians walking along the sidewalk and within the Capitol Mall area. The location is similar to the WWII Memorial at the corner of Cottage Street and Court Street, which has been engaging to pedestrians. Since the purpose of the wall is to engage pedestrians, the wall does not block vision clearance at the corner and is similar to the existing memorial the proposal equally meets the development standard.

***SRC 250.005(d)(2)(B): If located within a residential zone, the proposed development will not detract from the livability or appearance of the residential area.***

**Finding:** The subject property is located within an PM (Capitol Mall) zone; therefore, the criterion is not applicable.

***SRC 250.005(d)(2)(C): If more than one adjustment has been requested, the cumulative effect of all the adjustments result in a project which is still consistent with the overall purpose of the zone.***

**Finding:** One Class 2 Adjustment has been requested; therefore, this criterion is met.

## **9. Analysis of Tree Removal Variance Approval Criteria**

Salem Revised Code (SRC) 808.045(d) sets forth the following criteria that must be met before approval can be granted to a request for a Tree Regulation Variance. In this case, the applicant has requested to address the hardship criteria in SRC 808.045(d)(1).

**SRC 808.045(d)(1)(a): There are special conditions that apply to the property which create unreasonable hardships or practical difficulties which can be most effectively relieved by a variance.**

**Finding:** The applicant's project arborist, Bartlett Tree Experts, reviewed the trees and root conditions of these trees and provided recommendations in an arborist's memo and outlined below. The project arborist will provide prescriptive measures for working around the significant roots which will be included on the final Permit Drawings.

Tree #1109 (40" Douglas Fir): This tree is primarily surrounded by softscape with some pathways in the outer half of the root zone. The pathways will be elevated above the roots with drain rock between the roots and pavement to allow good air and moisture exchange. Prescriptive measures for working around the significant roots shall be included on the final Permit Drawing.

Tree # 10642 (45" Blue Atlas Cedar): Per the arborist's recommendations, the design shall incorporate permeable pavers at an elevation above the roots in order to provide drain rock between the roots and base rock of the permeable pavers. This system will allow good air and moisture exchange. Prescriptive measures for working around the significant roots shall be included on the final Permit Drawing.

Tree # 11091 (31" Western Red Cedar): The design proposes using elevated decking to minimize impact to the root zone. Per the arborist's findings and recommendations, footings will be placed to avoid impacts to significant roots and steel joists will be used to frame the decking with footings located to avoid impacts to the significant roots.

The request is not to remove these three trees, but to impact more than 30% of the critical root zone. The applicant proposed to preserve them using construction methods to avoid impacts to the trees. Not impacting more than 30% of the critical root zoned of the trees creates an unreasonable hardship that can most effectively be relieved by approval of the variance. The following conditions apply:

**Condition 2:** The impacted 31-inch Wester Red Cedar, 45-inch Blue Atlas Cedar and 40-inch Douglas Fir tree shall be preserved and are not authorized for removal.

**Condition 3:** The applicant shall follow all Arborist recommendation and construction methods within the Critical Root Zone of each identified tree, as described in **Attachment C**.

**SRC 808.045(d)(1)(b): The proposed variance is the minimum necessary to allow the otherwise lawful proposed development of activity.**

**Finding:** No other options exist to install the memorial on the property. Therefore, the applicant's proposal to impact 30 percent of the critical root zone of three significant trees is the minimum needed to allow for the lawful development of the abutting properties.

## 10. Conclusion

Based upon review of SRC Chapters 220, 250, and 808, the applicable standards of the Salem Revised Code, the findings contained herein, and due consideration of comments received, the application complies with the requirements for an affirmative decision.

### **IT IS HEREBY ORDERED**

Final approval of Class 3 Site Plan Review, Class 2 Adjustment, Tree Variance Case No. SPR-ADJ-TRV22-36 is hereby **APPROVED** subject to SRC Chapters 220, 250, and 808, the applicable standards of the Salem Revised Code, conformance with the approved site plan included as Attachment B, and the following conditions of approval:

- Condition 1:** The applicant shall plant six trees, at least 1.5-inch caliper in size, within the 20-foot setback. Two trees shall be abutting State Street and Four abutting Cottage Street NE.
- Condition 2:** The impacted 31-inch Wester Red Cedar, 45-inch Blue Atlas Cedar and 40-inch Douglas Fir tree shall be preserved and are not authorized for removal.
- Condition 3:** The applicant shall follow all Arborist recommendation and construction methods within the Critical Root Zone of each identified tree, as described in Attachment C.



Olivia Dias, Current Planning Manager,  
on behalf of Lisa Anderson-Ogilvie,  
AICP, Planning Administrator





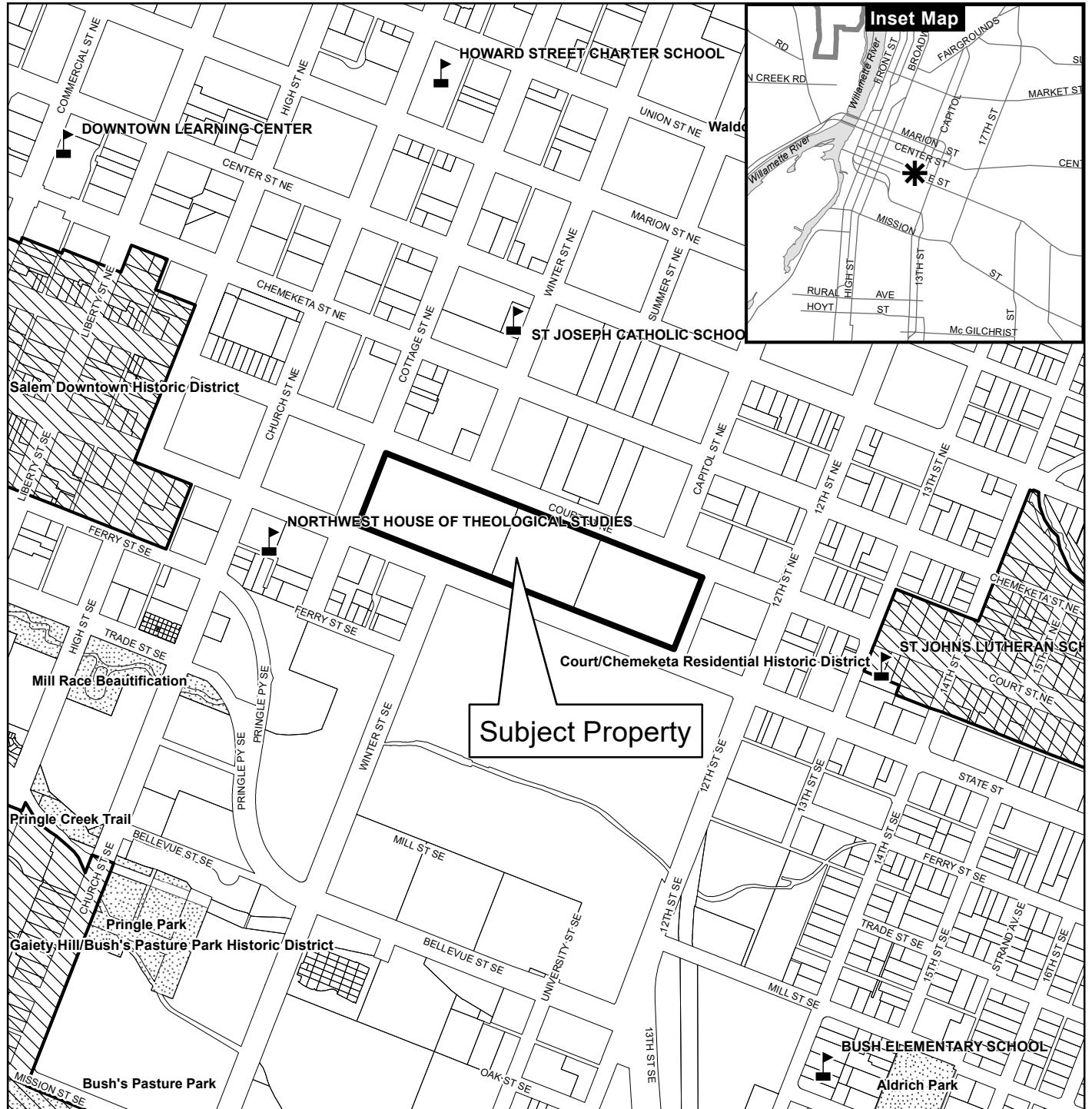

- Attachments: A. Vicinity Map  
B. Proposed Development Plans  
C. Arborist Report  
D. Public Works Memo

<http://www.cityofsalem.net/planning>

# Vicinity Map 900 Court Street NE



**Legend**

-  Taxlots
-  Urban Growth Boundary
-  City Limits
-  Outside Salem City Limits
-  Historic District
-  Schools
-  Parks



This product is provided as is, without warranty. In no event is the City of Salem liable for damages from the use of this product. This product is subject to license and copyright limitations and further distribution or resale is prohibited.

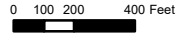

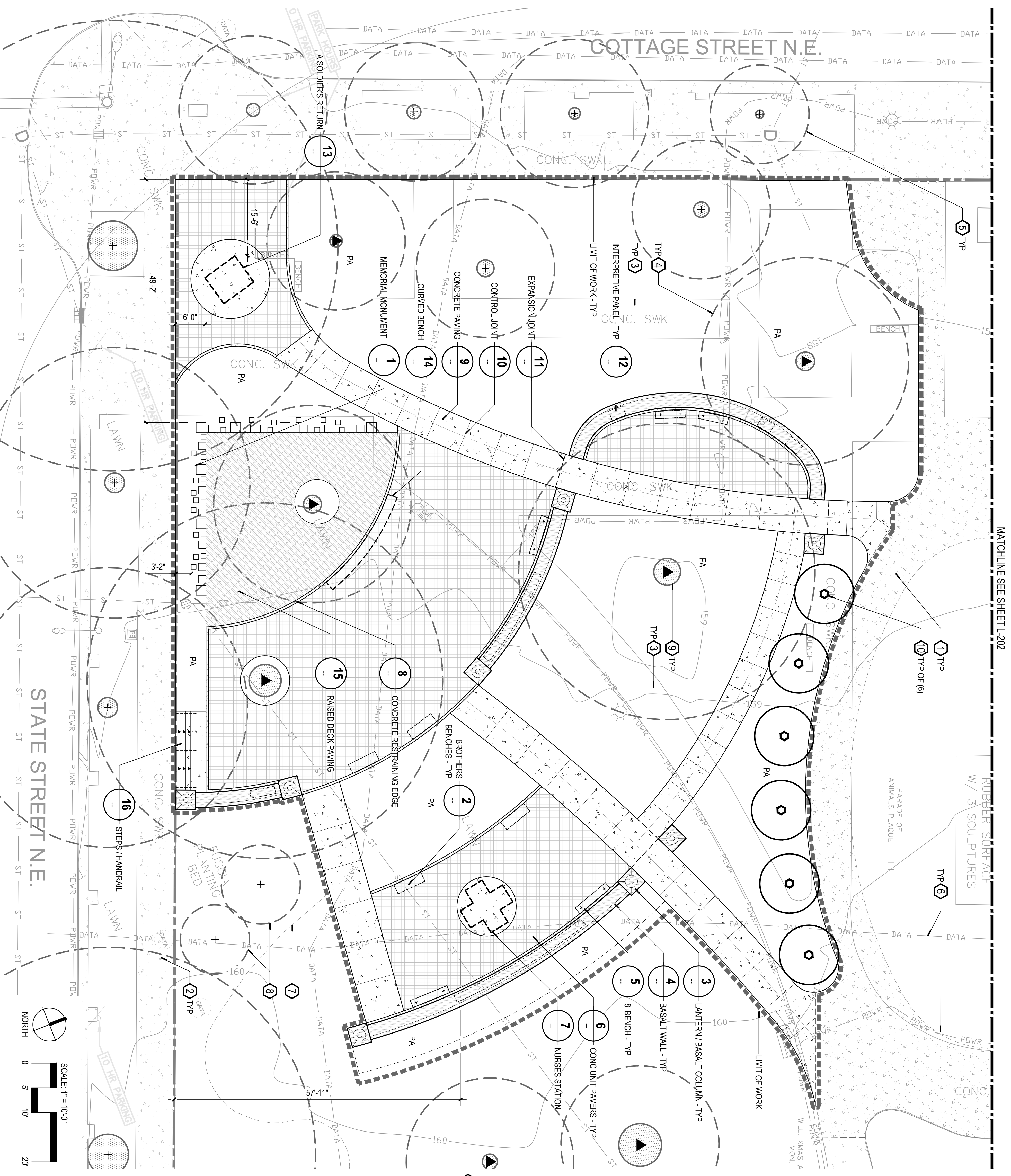

MATCHLINE SEE SHEET L-202

RUBBER SURFACE  
W/ 3 SCULPTURES

PARADE OF  
ANIMALS PLAQUE

WILL XMAS A  
MON.

### MATERIALS LEGEND

SYMBOL	ITEM
	CONCRETE PAVING
	EXISTING CONCRETE PAVING
	PROPOSED FUTURE PAVING BY OTHERS
	DOWELED EXPANSION JOINT
	CONTROL JOINT
	CONCRETE UNIT PAVERS
	RAISED DECK PAVING
	LANTERN / BASALT COLUMN
	INTERPRETIVE PANEL
	CONCRETE RESTRAINING EDGE
	8 BENCH W/BACK
	BROTHERS BENCH
	BASALT COLUMNS / MEMORIAL MONUMENT
	LIMIT OF WORK
	PLANTING AREA

### SITE KEY NOTES

1. FUTURE PAVING IMPROVEMENTS BY OTHERS
2. EXISTING PAVING TO REMAIN UNDISTURBED - TYP
3. EXISTING CONIFER TREE TO BE REMOVED - TYP
4. EXISTING CONIFER TREE TO REMAIN UNDISTURBED - TYP
5. EXISTING DECIDUOUS TREE TO REMAIN UNDISTURBED - TYP
6. EXISTING UTILITIES - TYP
7. EXISTING EDGE OF PLANTING BED TO REMAIN UNDISTURBED - TYP
8. EXISTING RHODODENDRON AND ELM TO REMAIN UNDISTURBED
9. TREE TRUNK DIAMETER - TYP
10. MITIGATION TREES (6 - TOTAL) - SEE TREE PROTECTION PLAN

### SITE DATA

1. TOTAL SITE AREA = 22,005 SF / 0.5 ACRES
2. TOTAL PROPOSED PLANTING AREA = 11,266 SF / 0.258 ACRES
3. TOTAL PROPOSED PLANTING AREA / % OF TOTAL SITE AREA = 51%
4. TOTAL PROPOSED IMPERVIOUS PAVING = 8,951 SF / 0.20 ACRES
5. TOTAL EXISTING IMPERVIOUS PAVING TO BE REMOVED = 6,474 SF / 0.148 ACRES

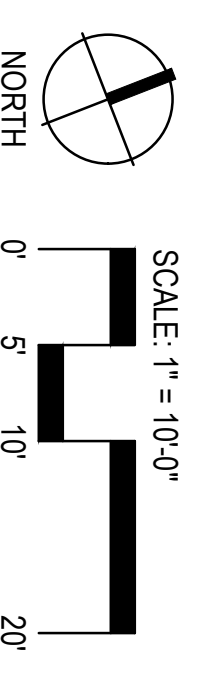

**Project:**  
Vietnam War Memorial  
  
Wilson Park  
Oregon State Capitol Grounds  
Salem, OR 97301

**Submittal:** Site Plan Review  
**Sheet Title:**  
Site Plan

**Date:** 07/01/2022  
**Revisions:**

**Drawn By:** RT  
**Checked By:** BJ  
**Job No.:** 190124.1  
**Approved:** BJ

**L-201**





**1** SITE ELEVATION - ELEMENTS WITHIN 10' OF RIGHT-OF-WAY  
VIEW FROM STATE STREET LOOKING NORTH

NOT TO SCALE

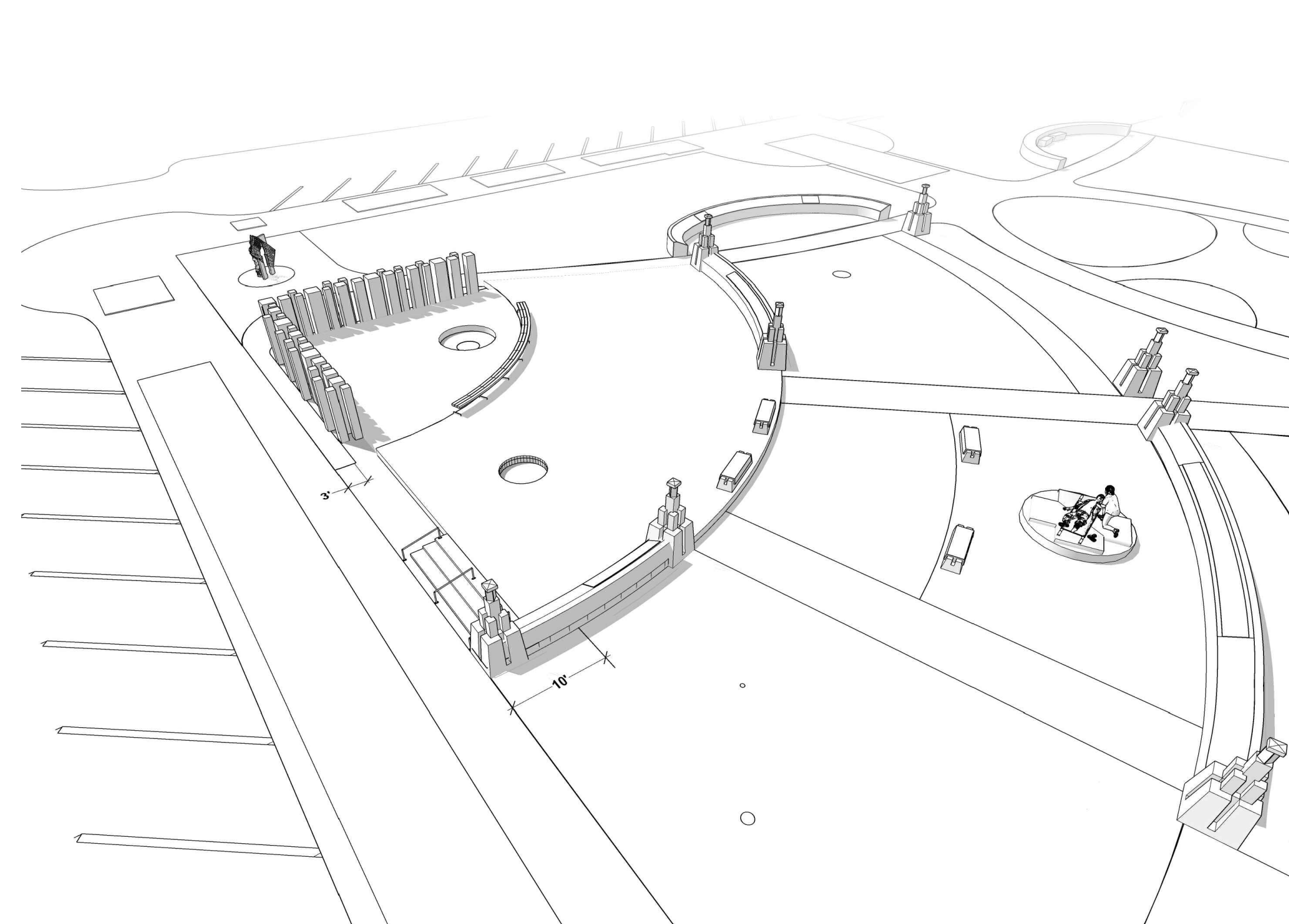

**2** SITE PERSPECTIVE  
VIEW FROM SOUTHEAST CORNER OF SITE AT STATE STREET NE LOOKING NORTH

NOT TO SCALE

June 21, 2022

Ben Johnson  
Greenworks  
110 SE Main St STE 100  
Portland, OR 97214



Tree Protection for Vietnam War Memorial

Dear Ben,

You contacted us about tree protection and preservation for three trees that are intended to be incorporated into a proposed memorial to be dedicated to veterans of the Vietnam War. The trees in question are located in the southwest corner of Willson Park, located in Salem, OR. Given the labor intensive activities surrounding the proposed construction, the City of Salem requested that site plans include appropriate protection of the subject trees as a condition of granting permits. An arborist report was requested that indicated that proposed measures for protection of the affected trees were appropriate. We met remotely via Microsoft Teams on June 10, 2022 to discuss the plans. This letter outlines my observations, analysis and recommendations from that meeting.

The three trees include the Embracing Tree, a western redcedar (*Thuja plicata*), which is planned to be the figurative foundation of the proposed memorial, largely due to its unique branch architecture (Photo 1). In addition, the Liberty Tree, an Atlas cedar (*Cedrus atlantica*) and a Douglas fir (*Pseudotsuga menziesii*) located slightly north of the two named trees, are located inside the construction envelope (See Page 4, Site Plan).



**Photo 1.** The Embracing Tree during Root Invigoration procedure. (04.29.2022)

The Embracing Tree was assessed and the root system was surveyed in April 2022 in conjunction with a Root Invigoration™ performed by Bartlett Tree Experts. The root collar of the Liberty Tree was also exposed and surveyed. The purpose of the survey was to locate the significant roots (those two inches in diameter and larger), and more importantly, the spaces between them to aid in determining where footings could be placed to support a deck, which will encompass much of the root zone of the Embracing Tree. The deck will be elevated, avoiding contact with the ground, which will avoid future interactions with tree roots. Outward to the northeast from the deck, a patio of permeable concrete pavers will be laid through the remainder of the Embracing Tree's root zone and that of the Liberty Tree. Rainwater will be allowed to penetrate through the patio surface, down to the roots of the two trees.

The Douglas fir will have two narrow concrete walkways installed just inside the north and west edges of its root zone, with an area of permeable concrete pavers between the western walkway and an interpretive panel. The remainder of the root zone is proposed to be kept as a planting area following construction (See Page 5, Hardscape Map).

The Vietnam War Memorial should have minimal effect on the three subject trees. Elevated decking mounted on footings deliberately placed in areas where no roots are located and using a paver system that allows water infiltration into the trees' root zones will greatly reduce the potential for injury to roots and lower trunks and minimize future interactions between roots and the structures associated with the memorial. The following recommendations will help to minimize any detrimental effects on the trees:

- Establish a Tree Protection Zone (TPZ) around trees to be preserved to prevent damage to roots and aboveground portions over the course of construction. Per Section 808.005 of the City of Salem's Unified Development Code, TPZs should be established as a radius of one foot per inch of trunk diameter at 4.5 feet above grade. The City uses the term Critical Root Zone to indicate the TPZ. For the purposes of this project, the two terms are synonymous.
- Delineate TPZs with above ground silt fencing fully encircling the TPZ of each tree. The Embracing Tree and the Liberty Tree have overlapping root zones, and their TPZs will also overlap. Their TPZs can be fenced off together as a single unit.
- The nature of the project will require some incursion into TPZs to place footings, assemble the decking, install the pavers, and to install the infrastructure necessary for the memorial. The silt fence can be moved to allow needed access into a tree's TPZ only while work is being done in that area and must be returned to its previous position upon completion of the work or the end of the workday, whichever comes first.
- A layer of wood chips 4-6 inches deep should be placed over the trees' root zones to prevent compaction of the soil underneath while construction progresses. Areas of higher traffic, whether foot traffic or vehicular, can have the added weight disbursed by placing  $\frac{3}{4}$ -inch plywood or similar material over them while construction is ongoing. Remove plywood and reduce wood chip depth to 3-4 inches when access into any tree's TPZ is no longer required. Care should be exercised in keeping wood chips away from the trunks and root collars of protected trees.
- No grading or storage of any materials or equipment is permitted inside any tree's TPZ.
- The silt fence should be kept intact and in good repair for the duration of the project.
- Ensure that protected trees are kept adequately irrigated in the absence of natural rainfall over the course of the project.

Means of supplying water during spells of hot and dry weather after the memorial is completed should be incorporated into the design. Soil samples should be taken periodically for analysis and any deficiencies discovered should be corrected to maintain tree health.

If you have any questions about my observations or recommendations, please contact me.



Sean Rinault  
ISA Board Certified Master Arborist PN-7889B  
ISA Tree Risk Assessment Qualified  
[srinault@bartlett.com](mailto:srinault@bartlett.com)

### **Limits of the Assignment**

This was not a tree risk assessment. As such, no trees were assessed for risk in accordance with industry standards, nor are there any tree risk ratings or risk mitigation recommendations provided within this report.

Care has been taken to obtain all information from reliable sources. All data has been verified insofar as possible; however, the consultant can neither guarantee nor be responsible for the accuracy of information provided by others.

Illustrations, diagrams, graphs, and photographs in this report, being intended as visual aids, are not necessarily to scale and should not be construed as engineering or architectural reports or surveys.

Information contained in this report covers only those items that were examined and reflects the condition of those items at the time of inspection. There is no warranty or guarantee, expressed or implied, that problems or deficiencies of the plans or property in question may not arise in the future.

There is no guarantee for the preservation of the trees contained in this report, however, the preservation plan is made with the best interest intended for the trees being preserved.

# SITE PLAN

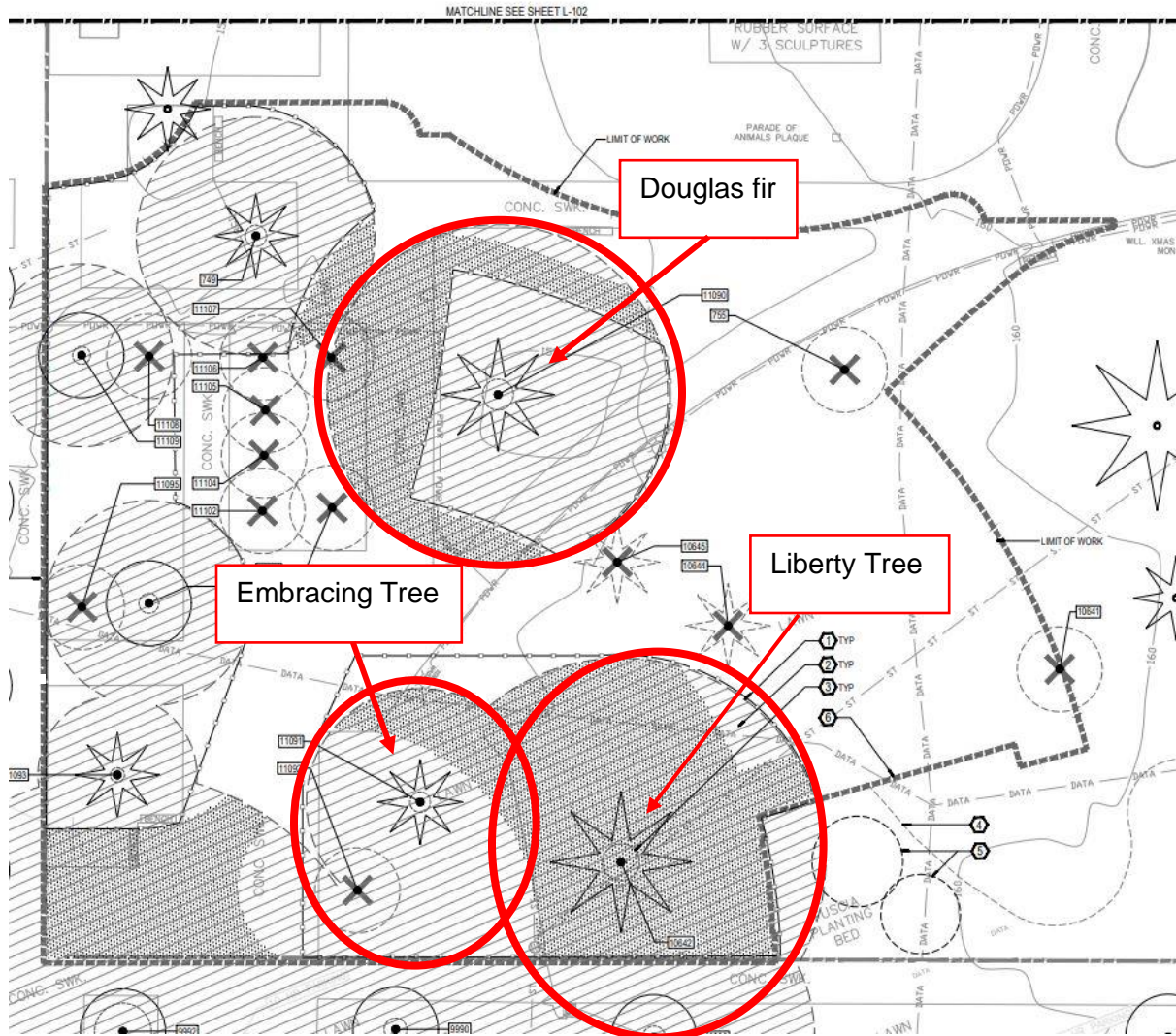

### TREE PROTECTION LEGEND

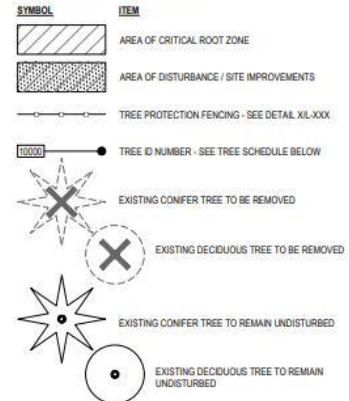

### SHEET NOTES

- TREES TO BE PRESERVED SHALL BE PROTECTED BY INSTALLATION OF TREE PROTECTION FENCING TO PREVENT INJURY TO TREE TRUNKS, ROOTS, OR SOIL COMPACTION WITHIN THE TREE CRITICAL ROOT ZONE. PROTECTION FENCING SHALL NOT BE MOVED OR REMOVED WITHOUT FIRST COORDINATING WITH THE OWNER'S REPRESENTATIVE.
- NO UTILITIES, VEHICLE MANEUVERING, SOIL COMPACTION, MATERIALS OR SPILLS STORAGE SHALL BE ALLOWED WITHIN THE TREE CRITICAL ROOT ZONE WITHOUT AUTHORIZATION FROM THE OWNER'S REPRESENTATIVE.
- ALL PROPOSED WORK INCLUDING BUT NOT LIMITED TO DEMOLITION, GRADING, AND TRENCHING OCCURRING WITHIN ANY TREE CRITICAL ROOT ZONE AREA SHALL BE DONE WITH WRITTEN APPROVAL FROM THE OWNER'S REPRESENTATIVE AND PERFORMED UNDER THE SUPERVISION OF THE PROJECT ARBORIST.
- ALL PROPOSED WORK WITHIN THE TREE CRITICAL ROOT ZONE AREA OF ANY STREET TREE SHALL BE COORDINATED WITH THE CITY OF SALEM URBAN FORESTER.

### KEY NOTES

- DRIP LINE / LIMIT OF CRITICAL ROOT ZONE - TYP
- TREE PROTECTION AREA - TYP
- TREE TRUNK DIAMETER - TYP
- EXISTING EDGE OF PLANTING BED TO REMAIN UNDISTURBED - TYP
- EXISTING RHODODENDRON AND ELM TO REMAIN UNDISTURBED
- LIMIT OF WORK

### EXISTING TREE SCHEDULE

TREE ID #	BOTANICAL NAME	COMMON NAME	DBH
745	PRINUS SPP	DOGWOOD	21"
755	*LILY	ELM	20"
9985	ACER SPP	MAPLE	24"
9993	POPULUS SPP	COTTONWOOD	24"
9992	PLATANUS SPP	SYCAMORE	60"
10041	*ACER SPP	MAPLE	18"
10642	*PICEA PUNGENS	BLUE SPRUCE	45"
10644	*PINUS SPP	PINE	58"
10643	*PINUS SPP	PINE	20"
11099	*PSEUDOTSUGA MENZIESII	DOUGLAS FIR	40"
11091	CEDRUS SPP	CEDAR	31"
11092	*ALNUS SPP	ALDER	24"
11093	CEDRUS SPP	CEDAR	27"
11094	PROXIMUS SPP	ASH	14"
11095	*FRAXINUS SPP	ASH	14"
11102	*MALUS SPP	CRABAPPLE	10"
11103	MALUS SPP	CRABAPPLE	8"
11104	MALUS SPP	CRABAPPLE	6"
11105	MALUS SPP	CRABAPPLE	6"
11106	MALUS SPP	CRABAPPLE	6"
11107	MALUS SPP	CRABAPPLE	6"
11108	*POPULUS SPP	POPLAR	50"
11109	POPULUS SPP	POPLAR	18"



Project: Vietnam War Memorial  
Wilson Park  
Union State Capitol Grounds  
Clatsop, OR 97101

Submitted: Site Plan Review  
Sheet Title: Tree Protection Plan

Date:	05/12/2022
Revisions:	

# HARDSCAPE MAP

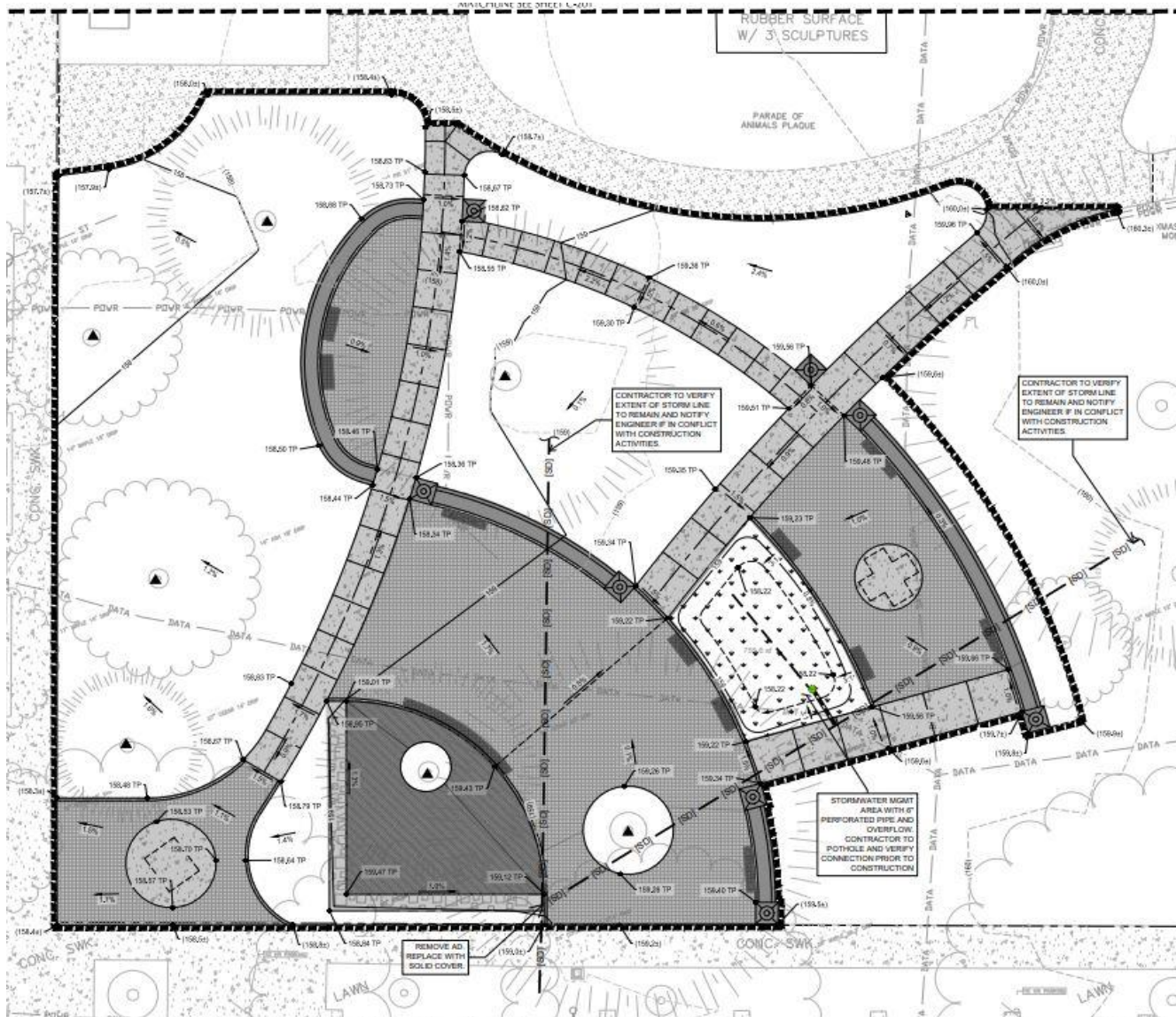

- SHEET NOTES**
1. SLOPES PROVIDED ON SLOPE ARROW ARE FOR REFERENCE ONLY.
  2. LANDINGS ON ACCESSIBLE ROUTES SHALL NOT EXCEED 2% IN ANY DIRECTION.
  3. ALL ACCESSIBLE ROUTES SHALL COMPLY WITH CURRENT ADA ACCESSIBILITY GUIDELINES FOR BUILDINGS AND FACILITIES (ADAA).

**SHEET LEGEND**

	PROPERTY LINE
	GRADE BREAK
	EX. CONTOUR MINOR
	EX. CONTOUR MAJOR
	CONTOUR MINOR (FG)
	CONTOUR MAJOR (FG)
	STORMWATER MANAGEMENT FACILITY

**GRADING LABEL LEGEND**

CALLOUT	DESCRIPTION
	GRADING SLOPE AND DIRECTION (DOWN-HILL)
	SPOT ELEVATION
	DESCRIPTION LISTED BELOW, NO DESCRIPTION MEANS TP OR TG
	BOS BOTTOM OF SWALE
	BS BOTTOM OF STEP
	BW BOTTOM OF WALL
	EG EXISTING GRADE
	FF FINISHED FLOOR
	HP HIGH POINT
	LP LOW POINT
	RS RIM OF STRUCTURE
	TG TOP OF GROUND
	TP TOP OF PAVEMENT
	TS TOP OF STEP
	TW TOP WALL
	EXISTING GRADE (MATCH WHERE APPLICABLE)

**AREAS LEGEND**

Description	Quantity	Unit
	894.6	sf
	9,932.2	sf
	7	Count
	758.6	sf

STORMWATER MANAGEMENT NOT REQUIRED. <10,000 SF NEW OR REPLACED IMPERVIOUS AREA.

TOTAL EXISTING TREES PRESERVED WITHIN THE PROJECT AREA = 7 • 50 SF = 350 SF. TREATMENT AREA REDUCTION IN TREATMENT <10% OF TOTAL IMPERVIOUS AREA.

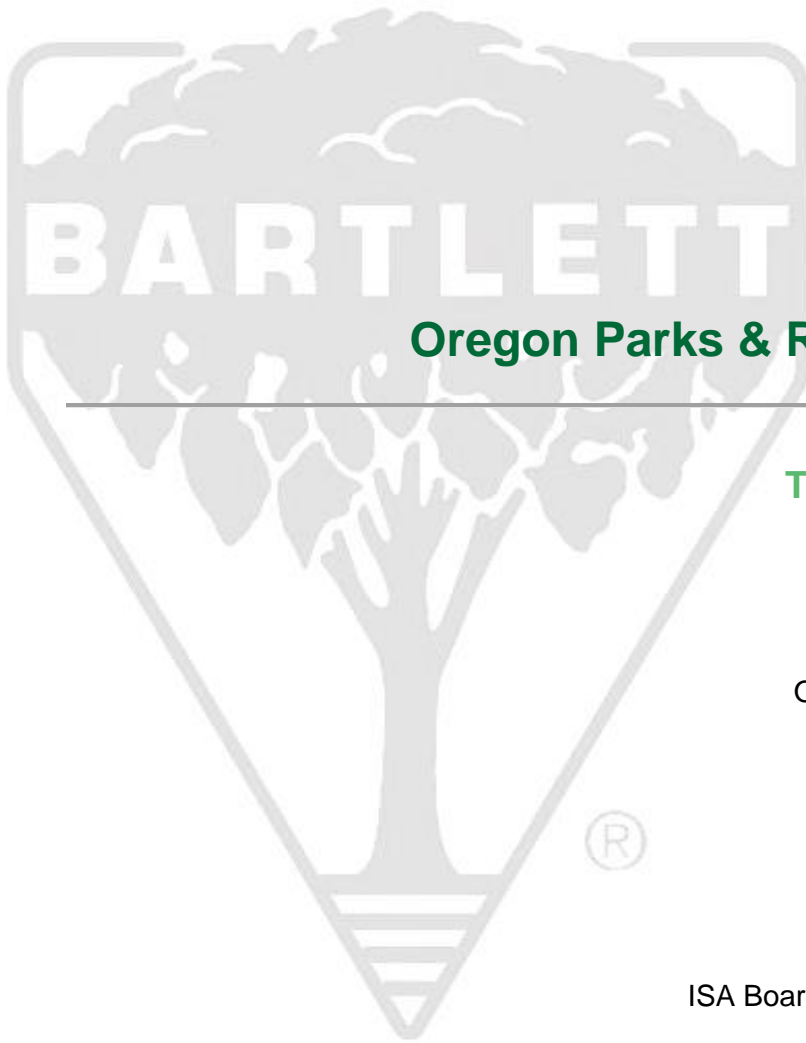

## Oregon Parks & Recreation Department

---

### Tree Risk Assessment Report

**PREPARED FOR:**

Oregon Parks & Recreation Department  
725 Summer St. NE C  
Salem, OR 97301

**PREPARED BY:**

Sean Rinault  
Associate Consulting Arborist  
ISA Board Certified Master Arborist #PN-7889B,  
ISA Tree Risk Assessment Qualified

**PROVIDED BY:**

Lyle Feilmeier  
Commercial Arborist Representative and Local Office Manager  
ISA Board Certified Master Arborist #MW-0173B,  
ISA Tree Risk Assessment Qualified



Bartlett Tree Experts  
Portland Area Office  
11814 SE Jennifer St.  
Clackamas, OR 97015  
503.722.7267

**Tree Risk Assessment Report**  
The Embracing Tree  
Willson Park, Oregon State Capitol  
May 25, 2022

**Table of Contents**

Summary .....	1
Introduction .....	3
Assessment Procedures .....	3
Observations.....	4
Tree Risk Assessment .....	6
Discussion .....	8
Conclusions and Risk Mitigation Options .....	10
Limitations.....	11
Assignment .....	11
Sonic Tomography .....	11
Limitations of Tree Risk Assessments .....	11
Site Map.....	13
ArborSonic 3D™ Tomograms, Central Stem.....	14
ArborSonic 3D™ Tomograms, Secondary Stems .....	15
Soil Nutrient Analysis Results .....	16
Tree Risk Assessment Definitions.....	17



## Summary

In April 2022, the Oregon Parks and Recreation Department (OPRD) agreed to the recommendation of completing a **Level 2: Basic assessment** and **Level 3: Advanced assessment of tree risk** on one western redcedar (*Thuja plicata*). The Embracing Tree was growing as a low-branched tree, having a central stem, and two secondary stems on opposite sides of the central stem, giving the appearance that it was offering an embrace to passers-by. It was located in the southwest corner of Willson Park, which occupied the area immediately to the west of the Oregon State Capitol building. The assignment was to determine the tree's **overall risk rating** for people and the surrounding property. The initial concern of OPRD was the possibility of compromised tree stability in light of visible decline of the tree's central stem. A secondary concern was whether the tree could be brought to a state of health and vigor such that it could serve in its planned role as anchor in a new memorial to be constructed and dedicated to veterans of the Vietnam War.

I visited the park on April 29, 2022, with fellow Bartlett team members Kris Maxwell and Adrian Sanchez, to assess the tree. I performed the Level 2 Basic assessment and the sonic tomography. Kris performed the climbing inspection, and Adrian performed the root collar excavation.

ArborSonic 3D™ tomograms indicated the presence of a significant loss of structural integrity at all three sensor planes on the central stem. A minor loss of structural integrity was detected at the sensor plane closest to the site of an open cavity on each of the secondary “arms,” with negligible loss of structural integrity at the sensor plane located 150cm out on each arm from its union with the central stem. The loss of structural integrity in the central stem appeared somewhat asymmetrical and lacked any visible external indicators, except the general decline of the central stem's foliar canopy and a cavity in the cross section of a large branch that had previously been removed. Using the methods outlined in this report and the results of the assessment of this tree, it is my professional judgment that the overall risk rating for root collar, trunk, crown, and branch failure is **low** within the next three years.



**Photo 1:** The Embracing Tree as seen from the northeast, showing its unique structure. (04.29.2022)

Options to mitigate the risk associated with the Embracing Tree are listed below.

- Option One:  
I recommend pruning to remove dead branches and reduce the relative size of the crown. The estimated residual risk of root collar, trunk, crown, or branch failure would remain *low*.
- Option Two:  
If the level of risk is unacceptable, then the tree should be removed and the stump ground, removing all risk of failures associated with the tree.
- Option Three:  
If no mitigation is done, the overall risk rating would remain low. The tree's risk may increase in the future as a result of not performing mitigation.

A Root Invigoration® was performed concurrently with the assessments on the Embracing Tree, starting with compressed air excavation of the root collar and scaffold roots to aid in mapping the significant roots (those greater than two inches in diameter).

Soil and root samples were taken, to assess nutrition and to test for root rot pathogens. I recommend supplementing the nutrients found to be in short supply by the soil analysis and establishing a soil care program to curtail the further development of the Phytophthora infection discovered in the root sample.

I also recommend installation and periodic use of a supplemental irrigation system during the increasingly warm and dry growing seasons, that delivers a slow, uniform application of water. It would improve the Embracing Tree's health and long-range success in anchoring the planned memorial. Use care to protect the base of the trunk from excessive moisture.

Further, once the memorial has been completed, the accessible soil surface under the tree's canopy should have a layer of mulch (wood chips) applied and maintained at a depth of three to four inches to provide organic matter, buffer soil temperatures, and reduce moisture loss due to evaporation. Be sure to keep the mulch at least 4 to 6 inches from the root collar to prevent potential rot issues from excess moisture retention at the collar and avoid "mulch volcanoes."

If the redcedar should remain, I recommend an **inspection interval** of every 12 months and after major storm events.

Tree risk assessment definitions are provided at the end of this report to help with understanding the terminology and with selecting the level of risk you are comfortable with when making decisions on your tree care needs.

## Introduction

Willson Park was located in Salem, OR, on the grounds of the State Capitol building. In April 2022, OPRD requested that Bartlett Tree Experts conduct a tree risk assessment of one tree with visible decline to help determine future management. The western redcedar was located at the southwest corner of the park, adjacent to the northeast corner of the intersection of Cottage and State Streets. The result of the project would be a written report describing our observations, findings, and recommendations.

After OPRD discussed the tree with Commercial Arborist Representative Lyle Feilmeier, it was agreed that my assignment was to:

1. Perform a ground based Level 2: Basic assessment of the tree and site to determine the tree or tree part's **likelihood of failure**, **likelihood of impact to targets**, and the **consequences** of failure and impact, in order to determine tree risk.
2. Perform a Level 3: Advanced assessment to provide additional information for the risk assessment. This assessment would include the use of sonic tomography to identify the potential loss of structural integrity within the lower trunk of the tree, and each of the two secondary stems.
3. Perform an aerial inspection of the upper canopy of the tree by means of a climbing arborist ascending the central stem.
4. Perform a root collar excavation with compressed air to expose the collar and major scaffold roots to determine their condition and inspect for root rot or decay issues
5. Provide a written report that documents the tree conditions of concern/defects detected, specific targets assessed, results of the assessments, results of the sonic tomography, risk ratings, mitigation options with estimated **residual risk**, and a recommended inspection interval.

## Assessment Procedures

The risk of root, root collar, trunk, crown, and branch failure for the redcedar via a ground-based basic assessment was performed. In addition, the lower trunk and the two secondary stems had an advanced assessment for failure performed using sonic tomography. A climbing arborist ascended the tree's central stem to assess the upper portions of the canopy that were not visible from the ground. Additionally, an AirSpade® was used to excavate the root collar and scaffold roots to inspect for rot or decay issues.

Performed concurrently with this risk assessment was a survey crew mapping the exposed roots for the purpose of determining where footings could be placed for the planned Vietnam War memorial without detrimental effect to the tree. Finally, the root excavation was the first step of a full Root Invigoration®, Bartlett's procedure for breaking up and adding amendments to compacted soil to create more hospitable rooting conditions for the subject tree. The assessments, root mapping, and Root Invigoration® occurred on March 29, 2021, and followed

the *International Society of Arboriculture's (ISA) Best Management Practices for Tree Risk Assessment* and *American National Standards Institute A300 Tree Risk Assessment Standard*).

Tree risk ratings are derived from a combination of three factors: the likelihood of failure, the likelihood of the failed tree part impacting a target, and the consequences of the target being struck. These factors are then used to categorize tree risk as **extreme**, *high*, *moderate*, or *low*. The factors used to define your risk rating are identified in this report.

Tools used in the assessment included an AirSpade® to examine soil conditions and loose bark, climbing gear and camera phone used by the climbing arborist who ascended the tree, a Dutch auger for obtaining soil samples, bypass pruning shears for collecting root samples, and a sounding mallet to detect concealed internal cavities.

In addition to these tools, sonic tomography was used to identify the potential loss of structural integrity within the lower trunk and the two secondary stems, and provide images used for analysis within this report (Photo 2). The ArborSonic 3D™ sonic tomography device uses sound waves to estimate the presence of internal loss of structural integrity. Sound waves move from sensor to sensor more quickly through wood that is intact and not structurally compromised. Sound waves have to move around compromised areas such as cracks, cavities, decay, or voids, causing it to take longer to reach the other sensors. The times for a sound wave to reach the other sensors are presented as a graphic image, called a tomogram. Estimated structural integrity is represented by a color scale from areas with high structural integrity (green) to areas of no structural integrity (blue).

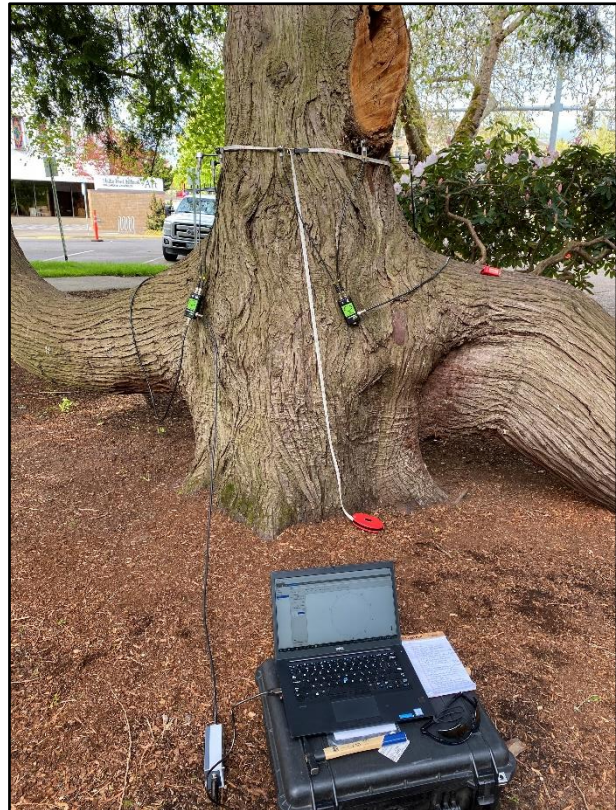

**Photo 2:** Sonic tomography readings were taken on three horizontal planes of the redcedar's central stem, and on two vertical planes on each of the two secondary stems. Significant loss of structural integrity was indicated at all three central sensor planes, and minor to negligible loss of structural integrity was detected at the four secondary sensor planes. (04.29.2022)

## Observations

The Embracing Tree was located near the southwest corner of Willson Park. The tree was growing on level grade with a top dressing of bark dust on the ground under the tree from the root collar to the edge of the dripline to the north and east, and out to a concrete path to the west and the sidewalk to the south. Larger trees were growing to the east, south, and west of the subject tree, effectively buffering it from the prevailing south to southwest winds during the fall to spring months, and the occasional strong east winds from the Columbia River Gorge.

Those same buffering trees were also partially shading the Embracing Tree, leading to a crown that was weighted slightly to the north.

The canopy of the mature western redcedar was supported by one vertical central stem that divided into three primary scaffolds at two feet above grade. The two secondary stems ran perpendicular to the central stem for approximately five feet before turning 90 degrees and orienting themselves upward. They were situated 180 degrees from one another, on a plane that was oriented northwest to southeast. The more northwesterly stem contacted the ground at the apex of its 90-degree angle. There were no roots found at that contact point.

The tree's form and structure were broad, open, and typical of the species, though fairly sparse. The overall vitality of the tree was low, with diminished shoot growth and canopy density. The central stem had copious amounts of dead branches approaching two inches in diameter. Inspection aloft discovered injuries to the upper portions of the central stem, where ice loading (presumably from the 2021 ice storm) likely broke several upper branches. While alive, the top of the central stem was not in good condition. The secondary stems appeared to be notably healthier, with fewer dead branches, and fuller foliar coverage. The secondary stems also had cables installed approximately halfway up securing them to the central stem.

Above and slightly offset from the union of the central stem with the northeasterly secondary stem was a cut approximately 20 inches high by 12 inches wide that had removed a large branch. It appeared to be about a year old, possibly also the result of a storm damage induced failure from February 2021. The top of the cut had a cavity roughly 5.5 inches in diameter (Photo 3). The cavity appeared to extend into the central stem, based on the hollow sound I observed when I struck the area with the mallet. The readings obtained with the ArborSonic® at the upper sensor plane appeared to support my observation.

The upper surface of the transverse portion of each of the secondary stems had a cavity open to the outside. Each was shallow in depth and extended approximately 12-15 inches along the top of each stem. Carpenter ants were active in the cavity of the southeasterly stem and started emerging when our activities commenced.

The root collar was slightly buried. However, the root flare was visible. There was uneven distribution of roots revealed during the AirSpade® excavation. Roots on the south side

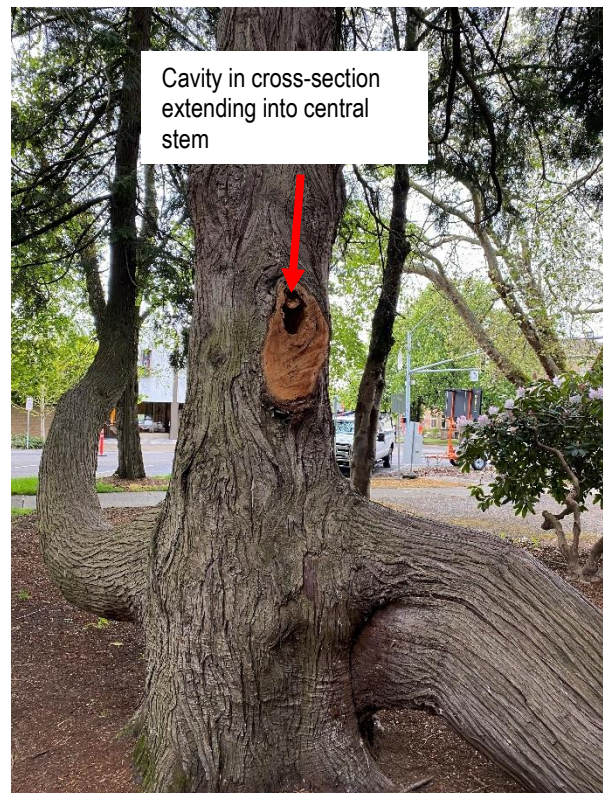

**Photo 3:** A large branch was removed prior to our assessment, revealing a cavity that extended into the central stem. (04.29.2022)

of the tree were generally sparse, with large spaces between most. Roots on the north side were denser, to the point of being matted. They were mapped as sections with distinct borders by the survey crew because individual roots on the north side could not be separated for individual measure and mapping.

The ArborSonic tomograms indicated the presence of a significant loss of structural integrity at all three of the sensor planes on the central stem. Readings were taken on two planes on the transverse sections of each of the secondary stems to get a sense of how deep any loss of structural integrity went, and how far along each stem it had progressed. The sensor plane on each that was closest to the union with the central stem (approximately 45cm from the union) showed minor loss of structural integrity, while the sensor plane on each located at 150cm from the union indicated negligible loss of structural integrity. Sounding the trunk and root collar with a mallet further substantiated the results of sonic tomography testing.

Laboratory results from the soil sample I took revealed a measured pH of 5.3, which is below the 5.5 minimum threshold of the preferred range for western redcedar. Boron, calcium, and manganese were also found in lower than recommended concentrations for the species. A copy of the results can be found in the appendix.

Testing of the root sample I collected exhibited sloughing of the outer tissue of the roots, weak unions of root branches, dead roots, and generally fewer fine roots than would be expected, consistent with an infection by *Phytophthora*. An Enzyme-Linked Immunosorbent Assay (ELISA) was run on the sample, which tested positive for *Phytophthora*.

Additional observations are provided in the table below:

Observations	
Species	Western redcedar ( <i>Thuja plicata</i> )
DBH	41 inches (center), 28 inches (NE), 23 inches SW)
Height	~40 feet
Condition	Fair
Soil Conditions	Clay; no apparent irrigation
Mulch	Fine bark compost
Defects	Co-dominant stems Cavity-stem (all three stems) Low vigor canopy Dead branches
Pests	Carpenter ants <i>Phytophthora</i>

### Tree Risk Assessment

After observing the site’s usage and **occupancy rates**, combined with my observations during the assessment, we determined that within the tree’s **target zone**:

- People were **frequent** targets,
- Infrastructure (lighting) was a **constant** target, and
- The paved path and the city sidewalk were constant targets.

It bears noting that the construction and completion of the Vietnam War memorial could change occupancy rates and potentially the overall risk rating for the Embracing Tree. This risk assessment applies only to those structures and features in existence at the time the assessment was made.

In determining the risk ratings, I considered a tree or tree part failure impacting a person to have one of the highest consequences, **significant** or **severe**. I considered a tree or tree part failure impacting a structure as having **minor** consequences.

I used a time frame of three years when I assessed the likelihood of tree or tree part failure. Following industry standards, the time frame is one factor used in the equation to determine tree risk. Trees and sites change on a daily basis. You should not consider this time frame a “guarantee period” for the risk assessment or that the tree will not fail or is safe within this time frame.

The main concerns observed during the assessment and their associated risk ratings are provided in the following table. Information not specifically summarized in the table was not considered a significant factor at the time of assessment.

Tree Part of Concern	Condition of Concern	Target	Likelihood of Failure	Likelihood of Impact	Likelihood of Failure & Impact	Consequences	Risk Rating
Trunk and Root collar	Loss of structural integrity	People in target zone	Improbable	Very low	Unlikely	Significant	Low
Trunk and Root collar	Loss of structural integrity	Lighting	Improbable	Very low	Unlikely	Minor	Low
Trunk and Root collar	Loss of structural integrity	Paved path and city sidewalk	Improbable	Low	Unlikely	Minor	Low
Crown and Branches	Dead branches	People in target zone	Probable	Low	Unlikely	Significant	Low
Crown and Branches	Dead branches	Lighting	Probable	Low	Unlikely	Minor	Low
Crown and Branches	Dead branches	Paved path and city sidewalk	Probable	Low	Unlikely	Negligible	Low

Using the methods outlined in this report and the results of the assessment of this tree, it is my professional judgment that this tree has an overall tree risk rating of *low*. If this level of risk is not acceptable to you, then mitigation actions should be taken as soon as practical to reduce the risk to an acceptable level.

### Discussion

Three conditions potentially elevate the risk associated with the subject tree:

- The loss of structural integrity within the lower trunk and root collar
- The unique co-dominant structure of the Embracing Tree’s three primary scaffolds
- The potential for crown collapse in the event of individual scaffold branch failure.

The tree was in fair condition. The loss of structural integrity detected within the lower trunk was significant. A visual representation of sonic tomography data showed a continuous column of loss of structural integrity between the upper and lower sensor planes that was fairly irregular in shape.

While the shell wall thickness to the east and west of the column was adequate for support, the asymmetrical shape of the column may increase the likelihood of trunk failure. Because all three stems were cabled, failure of one stem could cause a domino effect, resulting in one or both remaining stems failing.



While a co-dominant branching structure of a tree's scaffold limbs often could be a failure point, the Embracing Tree's two secondary stems lacked the narrow branch attachments and bark inclusions that would normally be expected. In fact, the unions of the secondary stems were perpendicular to the plane of the central stem. The cavities seen in the upper portions of the two secondary stems were also shallow and limited in their extent. Structurally, the tree appeared quite stable.

The amount of damage sustained by the upper reaches of the central stem could lead to the very top of it dying back, possibly with new growth emerging from a point further below. If that were to transpire, a strong shoot in a suitable location on the central stem could be trained to assume dominance and gradually recover and replace what was lost.

The Root Invigoration® not only allowed the roots to be mapped for reference in the design of the memorial, but the soil was de-compacted and amendments like biochar and compost were added to incorporate long-term nutritional benefit to the tree, as well as aid in preventing re-compaction. Further root growth is fostered by richer soil that is more easily penetrated by growing roots, which leads to improved growth of the aboveground portions.

Laboratory results of the soil sample I took indicated that the pH should be raised with the application of lime. Supplementation of boron and manganese would also help to give the tree more of what it needs to improve its ability to deal with environmental stresses, improve its overall health and vigor, and carry on into the future as an integral part of the planned memorial.

Concurrent with the nutritional and pH adjustments, a program should be instituted to suppress the advancement of the confirmed *Phytophthora* infection. The pathogen is a fungus-like organism with a reproductive spore that is capable of actively swimming in free water (found in times and areas of high soil saturation) to seek out a susceptible host. It infects and kills the roots it encounters, thereby reducing the numbers of roots that can move water and nutrients into the plant. This results in wilting and dieback of aboveground portions of a tree, and eventual outright death of a tree if conditions that favor the pathogen persist. Promoting drainage of the rooting area to prevent excess water in the soil and augmenting the soil profile with organic matter are the best ways of mitigating *Phytophthora* infection for the long term. The presence of organic matter (mulch) introduces fungi that break down plant fibers and cell walls as part of normal decomposition. Those same fungi also break down the cell walls of *Phytophthora*, effectively reducing its ability to cause infection.

The recent Root Invigoration® will serve to improve drainage and it introduced organic matter into the soil profile. There are treatments that can be made in the short term that can also suppress the pathogen and give the tree a window of opportunity to strengthen itself while the cultural changes begin to have their regulatory effects. We can provide proposals for both the fertilization and the *Phytophthora* suppression upon request.

Removal of dead branches and pruning weak branches in the upper portions of the central stem would improve the tree's overall appearance and begin the process of re-establishing a true leader on that stem.

Finally, I did not observe any obvious signs of an irrigation system near the tree. Western

redcedars are riparian species, living in relatively close proximity to water sources. The current trend of warmer growing seasons with less rainfall, coupled with competition from the larger trees nearby would make infrequent but deep watering a key component in the Embracing Tree's continued success.

## Conclusions and Risk Mitigation Options

I determined the overall tree risk rating for the Embracing Tree to be *low*.

Options to mitigate the risk associated with the western redcedar are listed below. Please make sure the estimated overall residual risk rating is acceptable to you before deciding on a specific option.

- Option One:  
I recommend pruning to remove dead branches and reduce the relative size of the crown. The estimated residual risk of root collar, trunk, crown, or branch failure would remain *low*.
- Option Two:  
If the level of risk is unacceptable, then the tree should be removed and the stump ground, removing all risk of failures associated with the tree.
- Option Three:  
If no mitigation is done, the overall risk rating would remain low. The tree's risk may increase in the future as a result of not performing mitigation.

I recommend raising the soil pH with the addition of lime and supplementing boron and manganese, per the results of the soil analysis.

Short term suppression of *Phytophthora* should be implemented while the recent Root Invigoration's effects begin their suppressive activities. Please inquire with your Bartlett Arborist Representative to obtain proposals for soil care and disease suppression.

Deep, infrequent warm season irrigation should be supplied, especially during periods of high temperature and drought conditions. Application should be slow and as even as possible, taking care to avoid direct contact of irrigation water with the root collar and lower trunk. Use of soaker hoses under a mulch layer can provide necessary moisture while keeping the delivery infrastructure out of sight.

The accessible soil surface under the tree's canopy should have a layer of mulch (wood chips are best) applied and maintained at a depth of three to four inches to provide organic matter, buffer soil temperatures, and reduce moisture loss due to evaporation. Avoid applying mulch directly on the root collar or in contact with the trunk.

If the redcedar should remain, I recommend an inspection interval of every twelve months and after major storm events.

All recommended work should be performed by qualified arborists and in accordance with industry accepted standards and best management practices set forth by the *American National Standards Institute* and the *International Society of Arboriculture*.

## Limitations

### Assignment

Our ground and aerial-based assessments of the Embracing Tree in Wilson Park were based on a single site visit on April 29, 2022. All photographs, samples, and readings were taken at the time the assessments were performed.

The assessments were limited to targets and structures in existence at the time the assessments were conducted.

### Sonic Tomography

Sonic tomography devices can provide sophisticated results related to tree structure. This is done by using sound wave technology that is directed through the tree and recorded. However, as with any higher-level technology, the amount of loss of structural integrity shown can vary based on the version of the program software used. Therefore, this technology can be limited and should not be used by the tree owner/manager as the sole decision-making criteria, but rather one of many factors used in the decision-making process.

### Limitations of Tree Risk Assessments

It is important for the tree owner or manager to know and understand that all trees pose some degree of risk from failure or other conditions. The information and recommendations within this report have been derived from the level of tree risk assessment identified in this report, using the information and practices outlined in the *International Society of Arboriculture's Best Management Practices for Tree Risk Assessment* and *American National Standards Institute A300 Tree Risk Assessment Standard*, as well as the information available at the time of the inspection. However, the overall tree risk rating, the mitigation recommendations, or any other conclusions do not preclude the possibility of failure from undetected conditions, weather events, or other acts of man or nature. Trees can unpredictably fail even if no defects or other conditions are present. Tree failure can cause adjacent trees to fail resulting in a "domino effect" that impacts targets outside the foreseeable target zone of this tree. It is the responsibility of the tree owner or manager to schedule repeat or advanced assessments, determine actions, and implement follow up recommendations, monitoring and/or mitigation.

Bartlett Tree Experts can make no warranty or guarantee whatsoever regarding the safety of any tree, trees, or parts of trees, regardless of the level of tree risk assessment provided, the risk rating, or the residual risk rating after mitigation. The information in this report should not be considered as making safety, legal, architectural, engineering, landscape architectural, land surveying advice or other professional advice. This information is solely for the use of the tree owner and manager to assist in the decision-making process regarding the management of their tree or trees. Tree risk assessments are simply tools which should be used in conjunction with the owner or tree manager's knowledge, other information and observations related to the specific tree or trees discussed, and sound decision making.

Thank you for the opportunity to provide this information. Please contact me if you wish to review these results or discuss the next steps to take with mitigation, or if I can be of any other service in the management of your landscape.

A handwritten signature in black ink that reads "Sean Rinault". The signature is fluid and cursive, with the first name "Sean" written in a larger, more prominent script than the last name "Rinault".

Sean Rinault  
ISA Board Certified Master Arborist #PN-7889B,  
ISA Tree Risk Assessment Qualified

Encl. **Site Map**  
**Advanced Assessment Readings**  
**Soil Nutrient Analysis Results**  
**Tree Risk Assessment Definitions**

## Site Map



Overall Tree Risk Rating: ● Low

### ArborSonic 3D™ Tomograms, Central Stem

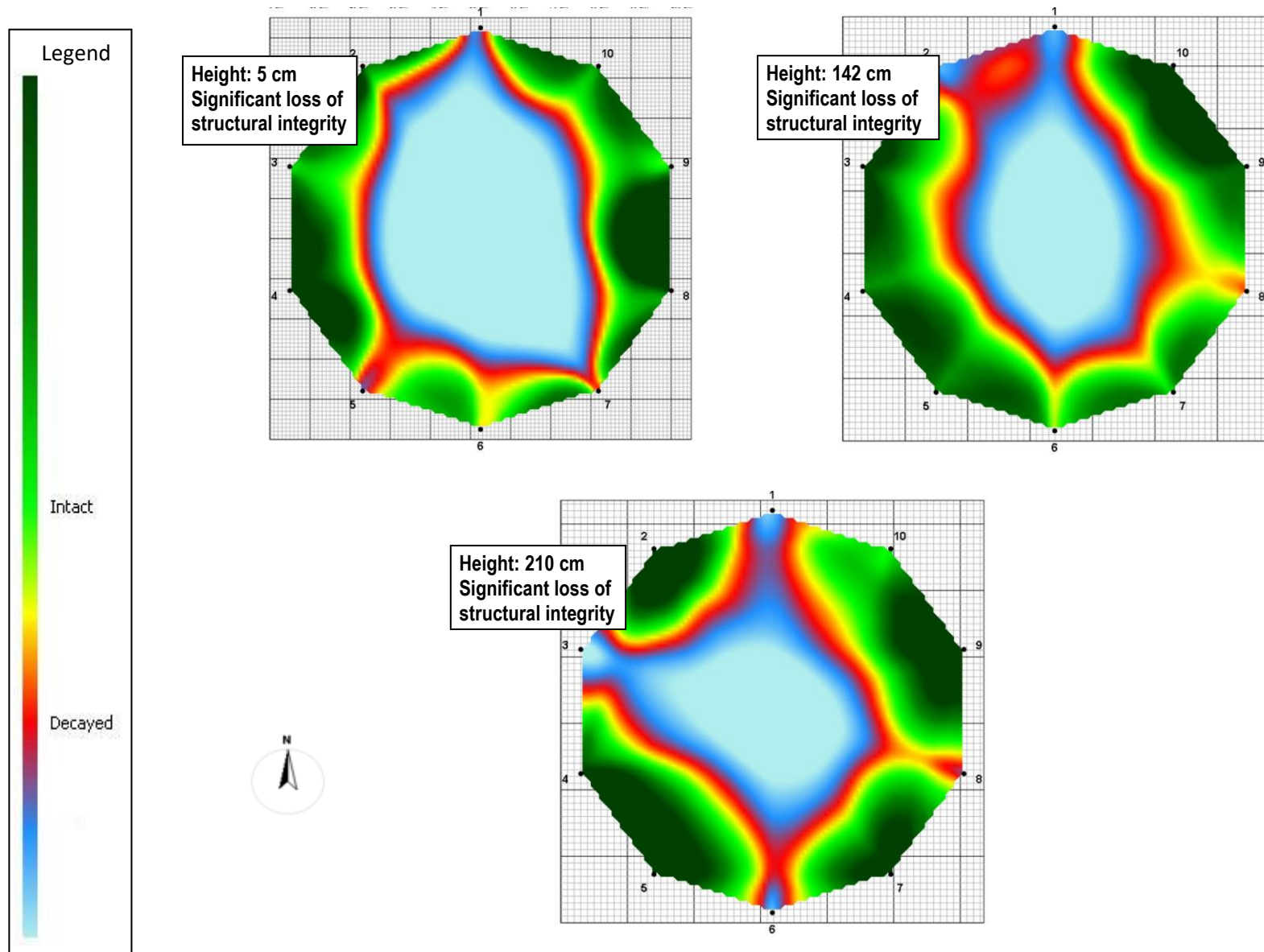

### ArborSonic 3D™ Tomograms, Secondary Stems

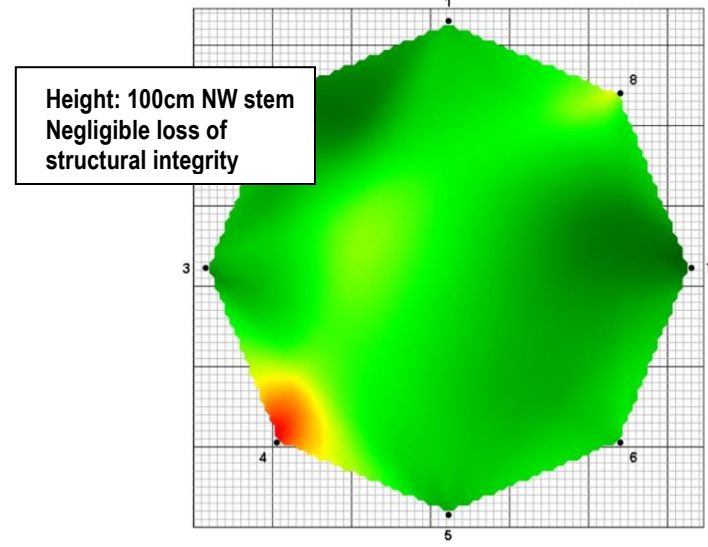
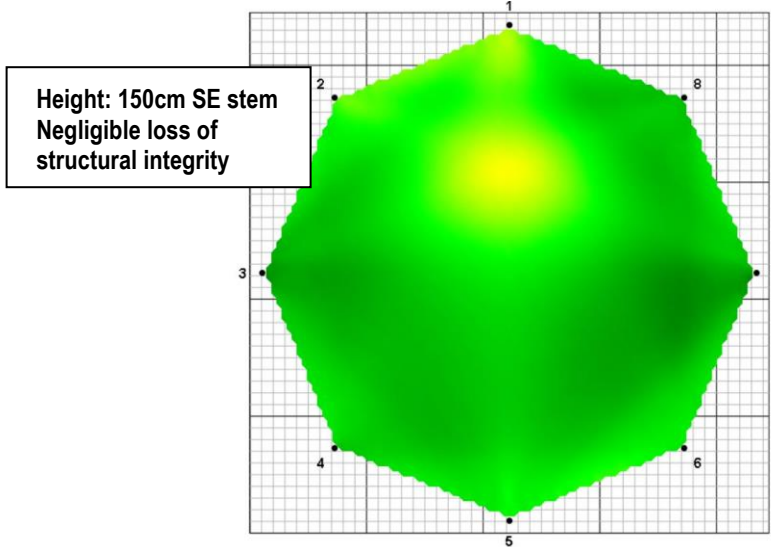
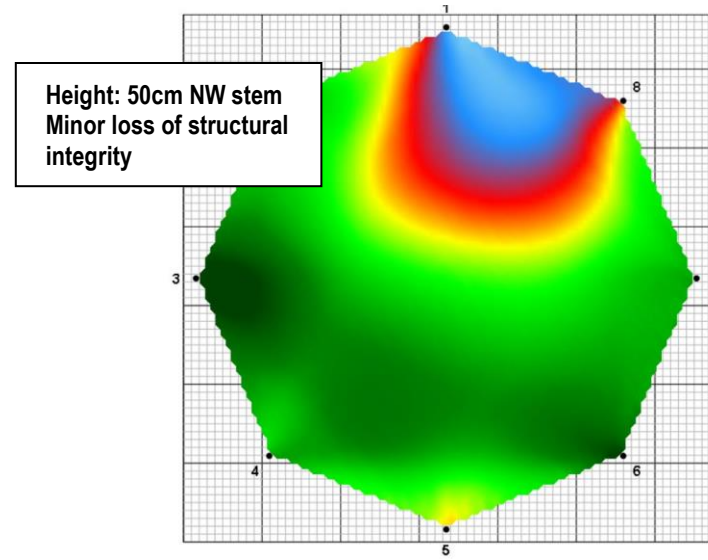
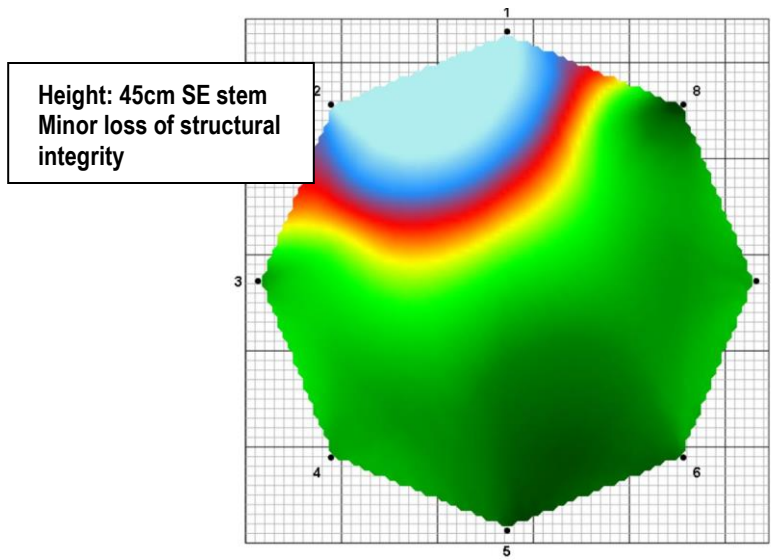

## Soil Nutrient Analysis Results

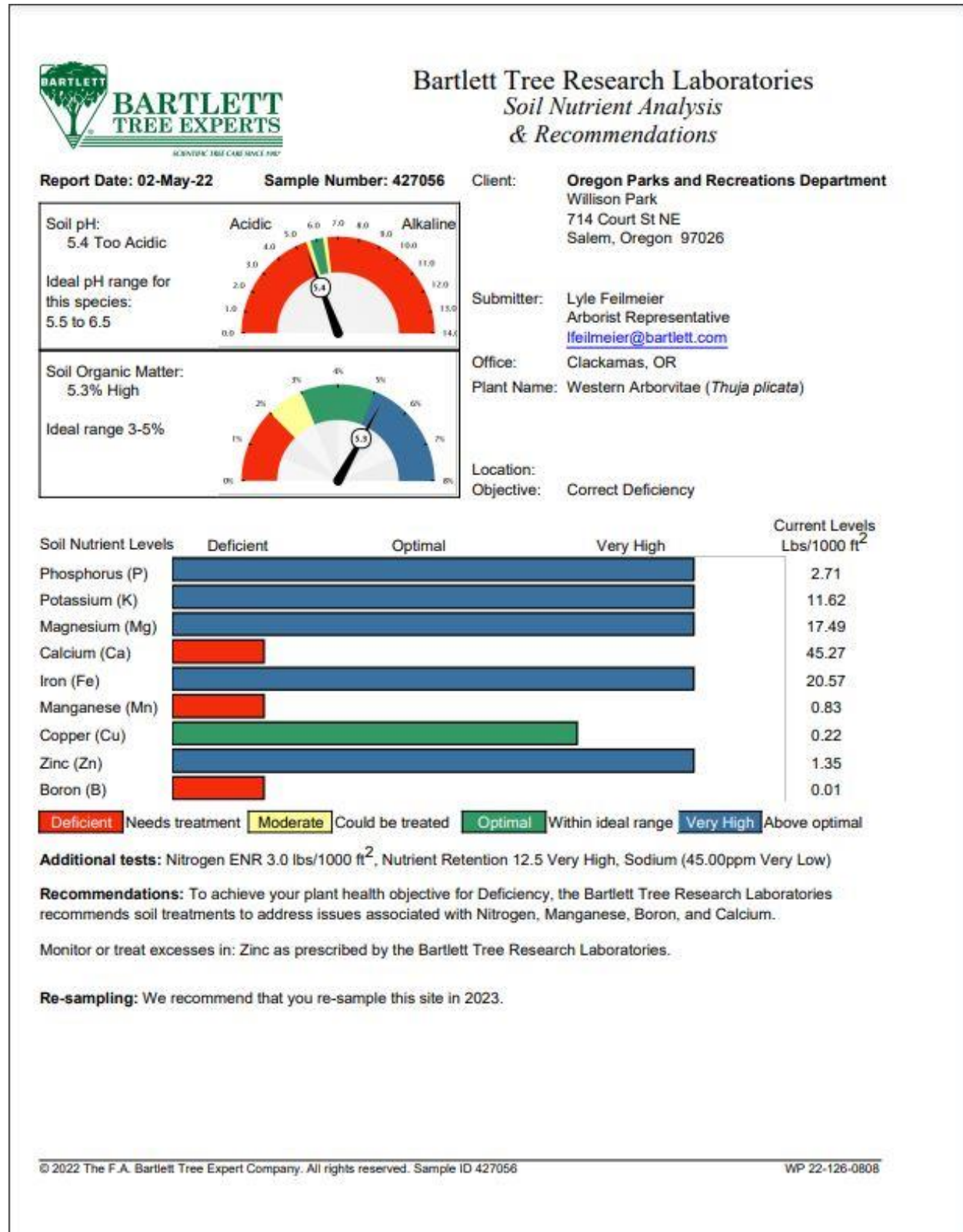



## Tree Risk Assessment Definitions

### Overview

**Tree risk assessment** has a unique set of terms with specific meanings. Specific terminology and procedures may be found in the International Society of Arboriculture's (ISA) *Best Management Practice (BMP) for Tree Risk Assessment* or the American National Standards Institute (ANSI) *A300 Tree Risk Assessment Standard*.

### Tree Risk Assessment Levels

The three levels of tree risk assessment defined in the *ANSI A300 Tree Risk Assessment Standard* are:

#### I. Level 1: Limited Visual Assessment

The visual assessment from a specific perspective (e.g. from the sidewalk, street, parking lot, wood line) of an individual tree or population of trees near specified targets. These assessments are conducted to identify obvious defects or specified conditions. The assessor typically views only of one side of the tree from the specified perspective.

Level 1 assessments are typically performed to quickly assess large populations of trees.

A Level 1 assessment requires the client to identify the location and/or selection criteria of trees to be assessed. The assessor will:

1. Determine the most efficient route and document the route taken.
2. Assess the tree(s) within the area from the defined perspective (e.g. walk-by, drive-by).
3. Record the location of trees that meet the defined criteria (e.g. significant defects or other conditions of concern).
4. Evaluate the risk (risk rating is optional).
5. Identify trees requiring a higher level of assessment (Level 2 or Level 3) and/or prompt action.
6. Submit risk mitigation recommendations and/or report.

Limitations: Level 1 assessments are the least thorough means of assessment. They are typically from one perspective, such as a walk-by, a drive-by, or a fly-over. This level of assessment is most commonly used to prioritize higher-risk trees within larger groups of trees when budgetary, time, or other management factors are a concern. Given the visual restrictions, the information can be limited. Some conditions may not be visible from the one-sided inspection. Not all conditions are visible at all times of the year, and the assessment may not be adequate to make a risk mitigation recommendation. Residual risk designations for trees may not be included.

#### II. Level 2: Basic Assessment

A Level 2 assessment is a detailed visual inspection of a tree and its surrounding site and a synthesis of the information collected. It requires a 360° inspection around a tree including the site, visible buttress roots, trunk, branches, and crown.

The assessment may include the use of tools such as binoculars, mallet, or probe at the discretion of the assessor or at the request of the owner/manager.

The assessor will:

1. Locate and identify the tree or trees to be assessed.
2. Determine the targets and target zone for the tree or tree part(s) of concern.
3. Review the site history and conditions, and species failure profile.
4. Assess potential load on the tree and its parts.
5. Assess general tree health.
6. Inspect the tree visually and using binoculars, mallet, probes, and/or shovels, as desired by the arborist or as specified in the Scope of Work.
7. Record observations of site condition, defects, indicators of internal defects, and response growth.
8. If necessary, recommend a Level 3 advanced assessment.
9. Analyze data to determine the likelihood of failure, likelihood of impact and consequences of failure in order to evaluate the degree of risk.
10. Develop mitigation options and estimate residual risk for each option.
11. Recommend a re-inspection intervals,
12. Develop and submit the report/documentation.

Limitations: Level 2 assessments only include conditions and defects that can be detected from a ground-based visual inspection on the day of the assessment. Internal below-ground, or upper-crown conditions, decay, and defects, may not be detected.

### III. Level 3: Advanced Assessment

A Level 3 assessment is performed to provide detailed information about specific tree parts, defects, targets, or site conditions. These are usually conducted in conjunction with or after a Level 2 assessment with owner/manager approval. Specialized equipment, data collection and analysis, and/or expertise are usually required for Level 3 assessments.

A Level 3 assessment provides detailed information about a specific tree part or condition. It involves the use of specialized equipment or techniques. The assessor will:

1. Locate and identify the tree or trees to be assessed.
2. Determine the targets and target zone for the tree or tree part(s) of concern.
3. Review the site history and conditions, and species failure profile.
4. Assess potential load on the tree and its parts.
5. Assess general tree health.
6. Inspect the tree using advanced techniques as specified in the Scope of Work.
7. Record results from advanced techniques.
8. Analyze data to determine the level of risk.
9. Develop mitigation options and estimate residual risk for each option.
10. Recommend a re-inspection intervals.
11. Recommend other advanced assessments if necessary.
12. Develop and submit the report/documentation.

\*Items 1-5 may be included in the associated Level 2 assessment.

Level 3 procedures and methodologies, which are referred to as technologies, may

include:

Procedure	Methodology
Aerial inspection and evaluation of structural defects in upper stems and branches	<ul style="list-style-type: none"> <li>• visual inspection from within the tree crown or from a lift</li> <li>• unmanned aerial vehicle (UAV) photographic inspection</li> <li>• decay testing of branches</li> </ul>
Detailed target analysis	<ul style="list-style-type: none"> <li>• property value of anything potentially impacted by tree failure</li> <li>• use and occupancy statistics</li> <li>• potential disruption of activities such as road blockage or an electrical outage</li> </ul>
Detailed site evaluation	<ul style="list-style-type: none"> <li>• history evaluation</li> <li>• soil profile inspection to determine root depth</li> <li>• soil mineral and structural testing</li> </ul>
Decay testing	<ul style="list-style-type: none"> <li>• increment boring</li> <li>• drilling with small-diameter bit</li> <li>• resistance-recording drilling</li> <li>• single path sonic (stress) wave</li> <li>• sonic tomography</li> <li>• electrical impedance tomography</li> <li>• radiation (radar, X-ray)</li> <li>• advanced analysis for pathogen identification</li> </ul>
Health evaluation	<ul style="list-style-type: none"> <li>• tree ring analysis (in temperate zone trees)</li> <li>• shoot length measurement</li> <li>• detailed health/vigor analysis</li> <li>• starch assessment</li> </ul>
Root inspection and evaluation	<ul style="list-style-type: none"> <li>• root and root collar excavation</li> <li>• root decay evaluation</li> <li>• ground-penetrating radar</li> <li>• detailed assessment of tree exposure and protection</li> </ul>
Storm/wind load analysis	<ul style="list-style-type: none"> <li>• computer-based estimations according to engineering models</li> <li>• wind reaction monitoring over a defined interval</li> </ul>
Measuring and assessing the change in trunk lean	<ul style="list-style-type: none"> <li>• visual documentation</li> <li>• digital level</li> </ul>
Load testing	<ul style="list-style-type: none"> <li>• hand pull</li> <li>• measured static pull</li> <li>• measured tree dynamics</li> </ul>

Limitations: Level 3 assessments that include the use of specialized technologies may have uncertainty and require qualified estimations. Exact measures may not be feasible.

## Common Terminology

The most common terms are provided below, and were taken or modified from the ISA and ANSI documents.

### General Terms Used Throughout Reports

**Inspection interval** is the recommended amount of time between inspections or assessments.

**Occupancy rates** categorize the estimated time that a target is physically within a target zone. Occupancy rate is classified as rare, occasional, frequent, or constant.

**Overall risk rating** is the highest individual risk identified for the tree.

**Residual risk** is the estimated level of risk after the recommended mitigation.

**Risk** is the likelihood of an event and its consequences.

**Risk rating** for a tree or tree part is the combination of the likelihood of failure, likelihood of impact, and the consequences

**Time frame** is the length of time (typically a one, two, or three-year period) the assessor considers when determining the likelihood of failure of a tree or tree part. A short time frame may result in a lower likelihood of failure rating (less likely to fail) where a longer time frame may result in a higher likelihood of failure rating (more likely to fail). The time frame is one factor in the equation to determining the likelihood of failure of a tree or tree part. Changes in the targets, site use, occupancy rates, and tree and site conditions may result in changes to the likelihood of failure and tree risk, even if the time frame does not change. Tree and site changes are why the owner/manager should not consider the specified time frame a “guarantee period” for the risk assessment or that the tree will not fail or is safe within the stated time frame.

**Targets** are people, property, or activities that could be injured, damaged or disrupted by a tree or tree part failure.

**Targets and occupancy rates** are typically identified based on information derived from the client prior to conducting the assessment, as well as information during the limited time the assessor evaluates the tree and site. Targets, target zones, and occupancy rates may be adjusted based on observations during the assessment.

**Target zones** are the areas where a tree or tree part is likely to land if it were to fail. The target zone(s) is determined in the field at the time of the assessment.

**Trees** can generally be defined as woody plants that continue to grow each year, reaching a height of at least five feet.

**Tree parts** include branches, fruit, and trunks.

**Tree risk** is the likelihood of a tree failure impacting a target and the severity of the consequences.

**Tree risk assessment** is the systematic process used to identify, analyze, and evaluate tree risk. Tree risk assessments are generally conducted to assist the tree owner/manager to better understand the risk their trees pose so they can make management decisions to reduce or minimize those risks. Tree risk assessments focus on evaluating the structural integrity of the tree crown, branches, trunks, and roots and root collar.

**Tree risk assessors** are trained arborists or qualified professionals with experience in performing tree risk assessments.

### Terms Used to Communicate Occupancy Rates

**Constant** indicates a target is present in the target zone at nearly all times, 24 hours a day, seven days a week.

**Frequent** indicates a target is present in the target zone for a large portion of the day or week.

**Occasional** indicates a target is present in the target zone infrequently or irregularly.

**Rare** indicates a target zone is not commonly used by people or other mobile/movable targets.

### Terms Used to Communicate the Likelihood of Failure

**Imminent** indicates that failure has started or is most likely to occur in the near future, even if there is no significant wind or increased load.

**Probable** indicates that failure may be expected under normal weather conditions within the specified time frame.

### Terms Used to Communicate the Likelihood of Failure

**Possible** indicates that failure could occur, but is unlikely under normal weather conditions within the specified time frame.

**Improbable** indicates that failure is not likely during normal weather conditions and it may not fail in extreme weather conditions within the specified time frame.

### Terms Used to Communicate the Likelihood of Impacting a Target

**High** indicates that a failed tree or tree part will most likely impact a target.

**Medium** indicates the failed tree or tree part could impact the target but is not expected to do so.

**Low** indicates that the failed tree or tree part is not likely to impact a target.

**Very low** indicates that the likelihood of a failed tree or tree part impacting the specified target is remote.

### Terms Used to Communicate the Likelihood of a Failure Impacting a Target

**Very likely** to impact a target is reached by an imminent likelihood of failure and high likelihood of impact.

**Likely** to impact a target can be reached by an imminent likelihood of failure and medium likelihood of impact; or probable likelihood of failure and high likelihood of impact.

**Somewhat likely** to impact a target can be reached by one of the following combinations; an imminent likelihood of failure and low likelihood of impact; probable likelihood of failure and medium likelihood of impact; or possible likelihood of failure and high likelihood of impact.

**Unlikely** to impact a target can be reached by one of the following combinations; a possible or probable likelihood of failure and low likelihood of impact; possible likelihood of failure and medium likelihood of impact; improbable likelihood of failure with any likelihood of impact rating; or any likelihood of failure rating with very low likelihood of impact.

### Terms Used to Communicate the Consequences of Failure and Impact

**Severe** consequences could involve serious personal injury or death, high-value property damage, or major disruption to important activities

**Significant** consequences are those that could involve substantial personal injury, property damage of moderate to high value, or considerable disruption of activities

**Minor** consequences are those that are believed will only cause minor personal injury, low-to-moderate-value property damage, or small disruption of activities

**Negligible** consequences are those that are believed will not result in personal injury, will only involve low-value property damage, or disruptions that can be replaced or repaired

### Terms Used to Communicate Risk Ratings

**Extreme** risk applies in situations in which failure is imminent, there is a high likelihood of impacting the target, and the consequences of the failure are severe.

**High** risk situations are those for which consequences are significant and likelihood is very likely or likely; or consequences are severe and likelihood is likely.

**Moderate** risk situations are those for which consequences are minor and likelihood is very likely or likely; or likelihood is somewhat likely and consequences are significant or severe.

**Low** risk applies when consequences are negligible and likelihood is unlikely; or consequences are minor and likelihood is somewhat likely.

## Conclusion

The tree risk assessment process is not an exact science. Regardless of the level of assessment conducted, every assessment is limited to the trees identified in the scope of

services, conditions detectable at the time of the assessment, the level of communication with the owner/manager, and other conditions that affect the assessor's ability to collect information.

Not all defects and conditions are detectable, and not all tree failures can be predictable. Tree conditions do change over time. Tree inspections are recommended annually and after major weather event.



# MEMO

**TO:** Olivia Dias, Current Planning Manager  
Community Development Department

**FROM:** Glenn J. Davis, PE, CFM, Chief Development Engineer  
Public Works Department 

**DATE:** July 29, 2022

**SUBJECT: PUBLIC WORKS RECOMMENDATIONS**  
**SPR-ADJ-TRV22-36 (22-110042; 22-110045; 22-113625)**  
**900 COURT STREET NE**  
**VIETNAM WAR MEMORIAL**

## PROPOSAL

A Class 3 Site Plan Review for site improvements including walkways, memorial statues and viewing areas, and a Tree Variance to conduct ground distributing construction within 30 percent of the critical root zone of three significant trees. The proposal includes one Class 2 Adjustment to eliminate the opacity requirement for a proposed wall (part of memorial). For development site approximately eleven acres in size, zoned PM (Capital Mall) and PA (Public Amusement), and located at 900 Court Street NE 97301 (Marion County Assessors Map and Tax Lot number: 073W27AA / 200 & 300 and 073W26BB / 4900).

## SUMMARY OF FINDINGS

The proposed development meets applicable criteria related to Public Works infrastructure.

## FACTS

### **Streets**

1. Court Street NE
  - a. Standard—This street is designated as a major arterial street in the Salem TSP. The standard for this street classification is a 68-foot-wide improvement within a 96-foot-wide right-of-way.
  - b. Existing Conditions—This street has an approximate 60-foot improvement within a 100-foot-wide right-of-way abutting the subject property.

Code authority references are abbreviated in this document as follows: *Salem Revised Code* (SRC); *Public Works Design Standards* (PWDS); *Salem Transportation System Plan* (Salem TSP); and *Stormwater Management Plan* (SMP).

2. Cottage Street NE

- a. Standard—This street is designated as a local street in the Salem TSP. The standard for this street classification is a 30-foot-wide improvement within a 60-foot-wide right-of-way.
- b. Existing Conditions—This street has an approximate 60-foot improvement within a 100-foot-wide right-of-way abutting the subject property.

3. State Street NE

- a. Standard—This street is designated as a major arterial street in the Salem TSP. The standard for this street classification is a 68-foot-wide improvement within a 96-foot-wide right-of-way.
- b. Existing Conditions—This street has an approximate 60-foot improvement within a 100-foot-wide right-of-way abutting the subject property.

**Storm Drainage**

1. Existing Conditions

- a. An 18-inch storm main is located in Court Street NE.
- b. An 18-inch storm main is located in Cottage Street NE.
- c. A 21-inch storm main is located in State Street NE.

**Water**

1. Existing Conditions

- a. The subject property is located in the G-0 water service level.
- b. A 12-inch water main is located in Court Street NE.
- c. A 12-inch water main is located in State Street NE.

**Sanitary Sewer**

1. Existing Conditions

- a. A 24-inch sewer main is located in Court Street NE.
- b. A 48-inch sewer main is located in Cottage Street NE.



## **CRITERIA AND FINDINGS**

Analysis of the development based on relevant criteria in SRC 220.005(f)(3) is as follows:

### **Criteria: SRC 220.005(f)(3)(A) The application meets all applicable standards of the UDC (*Unified Development Code*)**

**Finding**—The subject property meets all applicable standards of the following chapters of the UDC: 601 – Floodplain; 802 – Public Improvements; 803 – Streets and Right-of-Way Improvements; 804 – Driveway Approaches; 805 – Vision Clearance; 809 – Wetlands; and 810 – Landslides.

Public Works staff has reviewed the Flood Insurance Study and Flood Insurance Rate Maps and has determined that no floodplain or floodway areas exist on the subject property.

According to the Salem-Keizer Local Wetland Inventory (LWI) the subject property does not contain any wetland areas or hydric soils.

According to the City's adopted landslide hazard susceptibility maps and SRC Chapter 810 (Landslide Hazards), there are no mapped landslide hazard areas on the subject property.

### **Criteria: SRC 220.005(f)(3)(B) The transportation system provides for the safe, orderly, and efficient circulation of traffic into and out of the proposed development, and negative impacts to the transportation system are mitigated adequately**

**Finding**—Cottage Street NE meets the right-of-way width and improvement standards for their street classification per the Salem TSP; therefore, no right-of-way dedication is required as a condition of the proposed development.

Court Street NE and State Street NE do not meet current standards for their classification per the Salem TSP. The proposal includes the installation of a Vietnam Memorial, which is not a building addition subject to SRC 803.040(a); therefore, no right-of-way dedication or street improvements are required.

### **Criteria: SRC 220.005(f)(3)(C) Parking areas and driveways are designed to facilitate safe and efficient movement of vehicles, bicycles, and pedestrians**

**Finding**—The existing driveway access onto Cottage Street NE provides for safe turning movements into and out of the property. No changes to the driveway approach are proposed.

**Criteria: SRC 220.005(f)(3)(D) The proposed development will be adequately served with City water, sewer, storm drainage, and other utilities appropriate to the nature of the development**

**Finding**—The Public Works Department has reviewed the applicant’s preliminary plan for this site. The water, sewer, and storm infrastructure are available within surrounding streets/areas and are adequate to serve the proposed development.

The applicant shall be required to design and construct a storm drainage system at the time of development. The application shall provide an evaluation of the connection to the approved point of discharge for new areas of impervious surface per SRC 71.075

The applicant shall design and construct all utilities (sewer, water, and storm drainage) according to the PWDS and to the satisfaction of the Public Works Director.

Prepared by: Laurel Christian, Program Coordinator  
cc: File